



**HERRO**  
A U S T R I A

**PTG**

**IG**

International Drills Germany GmbH

**BGS**  
technic  
WERKZEUGE

**Cenovnik  
za burgije**

# Spiralna burgija HSS - R valjana - crna

Burgija za univerzalno korišćenje ručne mašine za obradu čelika do 750 N / mm<sup>2</sup>

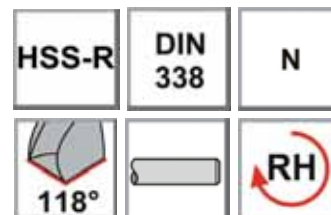
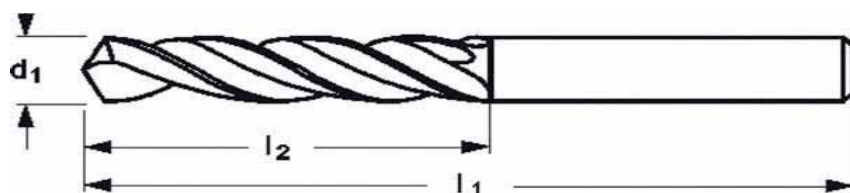

Broj artikla		Ø d-mm	L2 mm	L1 mm	Pakovanje industrijsko		Pakovanje blister	
Industrijsko	Blister				količina po pak	cena/din po kom	količina po pak	cena/din po pak
1100190003		0,3	3	19	10	12,84	*	*
1100200004		0,4	5	20	10	12,84	*	*
1100220005		0,5	6	22	10	12,74	*	*
1100240006		0,6	7	24	10	12,74	*	*
1100280007		0,7	9	28	10	12,74	*	*
1100300008		0,8	10	30	10	12,74	*	*
1100320009		0,9	11	32	10	12,74	*	*
1100360010	B	1,0	14	36	10	12,74	3	108,37
1100360011		1,1	14	36	10	21,12	*	*
1100380012		1,2	16	38	10	21,12	*	*
1100380013		1,3	16	38	10	21,12	*	*
1100400014		1,4	18	40	10	21,12	*	*
1100400015	B	1,5	18	40	10	21,12	3	120,93
1100430016		1,6	20	43	10	21,12	*	*
1100430017		1,7	20	43	10	21,12	*	*
1100460018		1,8	22	46	10	21,12	*	*
1100460019		1,9	22	46	10	21,12	*	*
1100490020	B	2,0	24	49	10	21,12	3	133,49
1100490021		2,1	24	49	10	21,12	*	*
1100530022		2,2	27	53	10	21,12	*	*
1100530023		2,3	27	53	10	21,12	*	*
1100570024		2,4	30	57	10	21,12	*	*
1100570025	B	2,5	30	57	10	21,12	3	133,49
1100570026		2,6	30	57	10	21,12	*	*
1100610027		2,7	33	61	10	21,12	*	*
1100610028		2,8	33	61	10	21,12	*	*
1100610029		2,9	33	61	10	21,12	*	*
1100610030	B	3,0	33	61	10	21,12	3	133,49
1100650031		3,1	36	65	10	21,12	*	*
1100650032	B	3,2	36	65	10	21,12	3	133,49
1100650033	B	3,3	36	65	10	21,12	3	133,49

# Spiralna burgija HSS- R valjana - crna

Burgija za univerzalno korišćenje ručne mašine za obradu čelika do 750 N / mm<sup>2</sup>



**HERRO**  
AUSTRIA

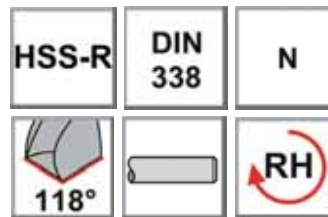

Broj artikla	Pakovanje	Ø d-mm	L2 mm	L1 mm	Pakovanje industrijsko		Pakovanje blister	
					količina po pak	cena/din po kom	količina po pak	cena/din po pak
1100700034		3,4	39	70	10	21,12	*	*
1100700035	<b>B</b>	3,5	39	70	10	25,30	2	112,56
1100700036		3,6	39	70	10	25,30	*	*
1100700037		3,7	39	70	10	25,30	*	*
1100750038		3,8	43	75	10	25,30	*	*
1100750039		3,9	43	75	10	25,30	*	*
1100750040	<b>B</b>	4,0	43	75	10	29,49	2	120,93
1100750041		4,1	43	75	10	29,49	*	*
1100750042	<b>B</b>	4,2	43	75	10	29,49	2	129,30
1100800043		4,3	47	80	10	29,49	*	*
1100800044		4,4	47	80	10	29,49	*	*
1100800045	<b>B</b>	4,5	47	80	10	29,49	2	129,30
1100800046		4,6	47	80	10	33,68	*	*
1100800047		4,7	47	80	10	33,68	*	*
1100860048		4,8	52	86	10	33,68	*	*
1100860049		4,9	52	86	10	37,68	*	*
1100860050	<b>B</b>	5,0	52	86	10	37,68	2	146,05
1100860051		5,1	52	86	10	42,05	*	*
1100860052		5,2	52	86	10	42,05	*	*
1100860053		5,3	52	86	10	42,05	*	*
1100930054		5,4	57	93	10	42,05	*	*
1100930055	<b>B</b>	5,5	57	93	10	42,05	2	154,43
1100930056		5,6	57	93	10	50,42	*	*
1100930057		5,7	57	93	10	50,42	*	*
1100930058		5,8	57	93	10	50,42	*	*
1100930059		5,9	57	93	10	50,42	*	*
1100930060	<b>B</b>	6,0	57	93	10	50,42	2	171,17
1101010061		6,1	63	101	10	58,80	*	*
1101010062		6,2	63	101	10	58,80	*	*
1101010063		6,3	63	101	10	58,80	*	*
1101010064		6,4	63	101	10	58,80	*	*
1101010065	<b>B</b>	6,5	63	101	10	67,17	1	132,93
1101010066		6,6	63	101	10	67,17	*	*
1101010067		6,7	63	101	10	67,17	*	*
1101090068	<b>B</b>	6,8	69	109	10	67,17	1	141,30
1101090069		6,9	69	109	10	67,17	*	*
1101090070	<b>B</b>	7,0	69	109	10	67,17	1	141,30

# Spiralna burgija HSS - R valjana - crna

Burgija za univerzalno korišćenje ručne mašine za obradu čelika do  $750 \text{ N} / \text{mm}^2$

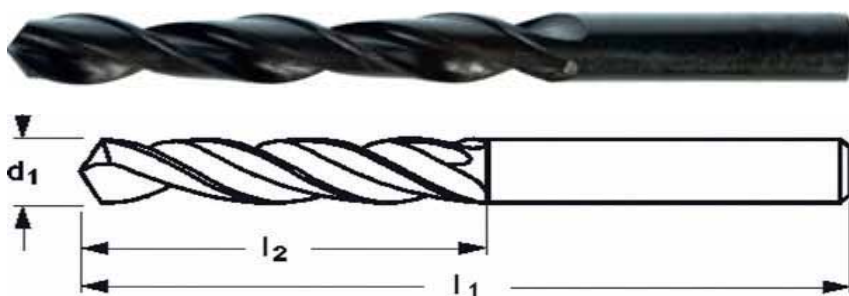

**HERRO**  
AUSTRIA

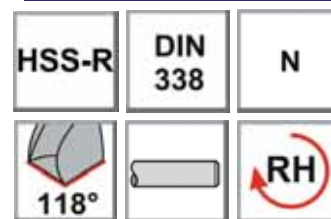

Broj artikla	Pakovanje Industrijsko	Pakovanje Blister	Ø d-mm	L2 mm	L1 mm	Pakovanje industrijsko		Pakovanje blister	
						količina po pak	cena/din po kom	količina po pak	cena/din po pak
1101090071			7,1	69	109	10	79,73	*	*
1101090072			7,2	69	109	10	79,73	*	*
1101090073			7,3	69	109	10	79,73	*	*
1101090074			7,4	69	109	10	79,73	*	*
1101090075		<b>B</b>	7,5	69	109	5	79,73	1	153,86
1101170076			7,6	75	117	5	92,29	*	*
1101170077			7,7	75	117	5	92,29	*	*
1101170078			7,8	75	117	5	92,29	*	*
1101170079			7,9	75	117	5	92,29	*	*
1101170080		<b>B</b>	8,0	75	117	5	92,29	1	166,42
1101170081			8,1	75	117	5	109,04	*	*
1101170082			8,2	75	117	5	109,04	*	*
1101170083			8,3	75	117	5	109,04	*	*
1101170084			8,4	75	117	5	109,04	*	*
1101170085		<b>B</b>	8,5	75	117	5	109,04	1	183,17
1101250086			8,6	81	125	5	125,79	*	*
1101250087			8,7	81	125	5	125,79	*	*
1101250088			8,8	81	125	5	125,79	*	*
1101250089			8,9	81	125	5	125,79	*	*
1101250090		<b>B</b>	9,0	81	125	5	125,79	1	199,92
1101250091			9,1	81	125	5	134,16	*	*
1101250092			9,2	81	125	5	134,16	*	*
1101250093			9,3	81	125	5	134,16	*	*
1101250094			9,4	81	125	5	134,16	*	*
1101250095		<b>B</b>	9,5	81	125	5	134,16	1	208,29
1101330096			9,6	87	133	5	155,10	*	*
1101330097			9,7	87	133	5	155,10	*	*
1101330098			9,8	87	133	5	155,10	*	*
1101330099			9,9	87	133	5	155,10	*	*
1101330100		<b>B</b>	10,0	87	133	5	155,10	1	229,23
1101330101			10,1	87	133	5	171,84	*	*
1101330102		<b>B</b>	10,2	87	133	5	171,84	1	245,97
1101330103			10,3	87	133	5	171,84	*	*
1101330104			10,4	87	133	5	171,84	*	*
1101330105		<b>B</b>	10,5	87	133	5	171,84	1	245,97
1101330106			10,6	87	133	5	188,59	*	*
1101420107			10,7	94	142	5	188,59	*	*

# Spiralna burgija HSS- R valjana - crna

Burgija za univerzalno korišćenje ručne mašine za obradu čelika do 750 N / mm<sup>2</sup>

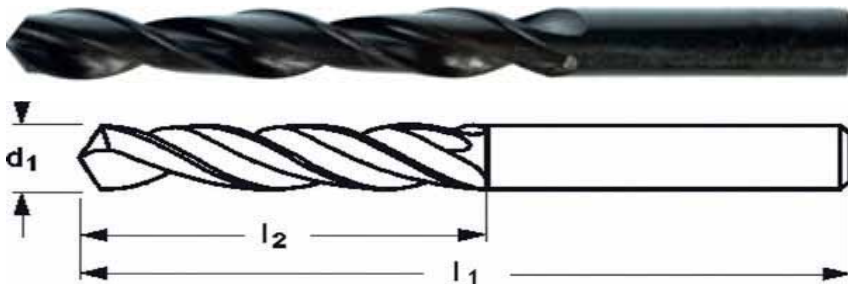

**HERRO**  
AUSTRIA

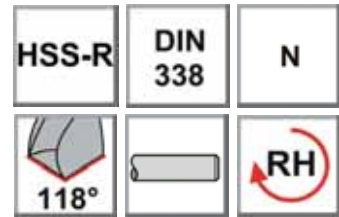

Broj artikla		Ø d-mm	L2 mm	L1 mm	Pakovanje industrijsko		Pakovanje blister	
Pakovanje Industrijsko	Pakovanje Blister				količina po pak	cena/din po kom	količina po pak	cena/din po pak
1101420108		10,8	94	142	5	188,59	*	*
1101420109		10,9	94	142	5	188,59	*	*
1101420110	<b>B</b>	11,0	94	142	5	188,59	1	262,72
1101420111		11,1	94	142	5	205,34	*	*
1101420112		11,2	94	142	5	205,34	*	*
1101420113		11,3	94	142	5	205,34	*	*
1101420114		11,4	94	142	5	205,34	*	*
1101420115	<b>B</b>	11,5	94	142	5	205,34	1	283,66
1101420116		11,6	94	142	5	243,02	*	*
1101420117		11,7	94	142	5	243,02	*	*
1101420118		11,8	94	142	5	243,02	*	*
1101510119		11,9	101	151	5	243,02	*	*
1101510120	<b>B</b>	12,0	101	151	5	243,02	1	317,15
1101510121		12,1	101	151	5	255,58	*	*
1101510122		12,2	101	151	5	255,58	*	*
1101510123		12,3	101	151	5	255,58	*	*
1101510124		12,4	101	151	5	255,58	*	*
1101510125	<b>B</b>	12,5	101	151	5	255,58	1	329,71
1101510126		12,6	101	151	5	280,70	*	*
1101510127		12,7	101	151	5	280,70	*	*
1101510128		12,8	101	151	5	280,70	*	*
1101510129		12,9	101	151	5	280,70	*	*
1101510130	<b>B</b>	13,0	101	151	5	280,70	1	354,83
1101600135		13,5	108	160	1	*	*	420,12
1101600140		14,0	108	160	1	*	*	444,73
1101690145		14,5	114	169	1	*	*	498,03
1101690150		15,0	114	169	1	*	*	514,43
1101780155		15,5	120	178	1	*	*	559,53
1101780160		16,0	120	178	1	*	*	616,94
1101820165		16,5	125	182,5	1	*	*	662,04
1101860170		17,0	125	186	1	*	*	686,64
1101920175		17,5	130	192,5	1	*	*	739,94
1101920180		18,0	130	192,5	1	*	*	793,25
1101960185		18,5	135	196	1	*	*	850,65
1102000190		19,0	135	200	1	*	*	883,45
1102050195		19,5	140	205	1	*	*	953,16
1102050200		20,0	140	205	1	*	*	985,96

# Spiralna burgija HSS -G brušena - svetla

Krstasto brušena burgija za univerzalno korišćenje stubne i ručne mašine za obradu čelika do 850 N/mm<sup>2</sup>

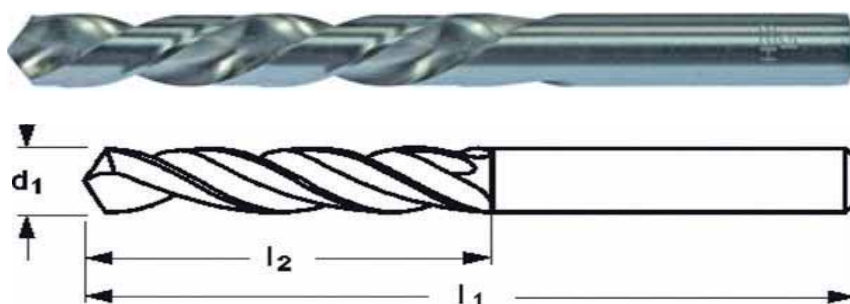

**HERRO**  
A U S T R I A

HSS-G	DIN 338	N
135°		RH

Broj artikla	Ø d - mm	L2 mm	L1 mm	Pakovanje Sadržji	Cena/din po/kom
1200360010	1,0	14	36	10	14,65
1200400015	1,5	18	40	10	28,67
1200490020	2,0	24	49	10	31,83
1200570025	2,5	30	57	10	41,33
1200610030	3,0	33	61	10	48,11
1200650032	3,2	36	65	10	51,28
1200650033	3,3	36	65	10	56,70
1200700035	3,5	39	70	10	56,70
1200750040	4,0	43	75	10	66,65
1200750042	4,2	43	75	10	73,43
1200800045	4,5	47	80	10	73,43
1200860050	5,0	52	86	10	82,48
1200930055	5,5	57	93	10	94,69
1200930060	6,0	57	93	10	105,54
1201010065	6,5	63	101	10	125,44
1201090068	6,8	63	101	10	148,04
1201090070	7,0	69	109	10	148,04
1201090075	7,5	69	109	5	165,68
1201170080	8,0	75	117	5	205,47
1201170085	8,5	75	117	5	224,92
1201250090	9,0	81	125	5	260,19
1201250095	9,5	81	125	5	277,82
1201330100	10,0	87	133	5	323,94
1201330102	10,2	87	133	5	349,72
1201330105	10,5	87	133	5	349,72
1201420110	11,0	94	142	5	404,43
1201420115	11,5	94	142	5	430,21
1201510120	12,0	101	151	5	492,16
1201510125	12,5	101	151	5	525,62
1201510130	13,0	101	151	5	569,93

# Spiralna burgija HSS - G brušena - svetla

Krstasto brušena burgija za univerzalno korišćenje za obradu čelika do 950 N/mm<sup>2</sup>

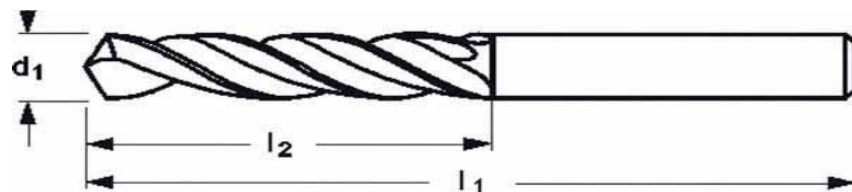

# PTG

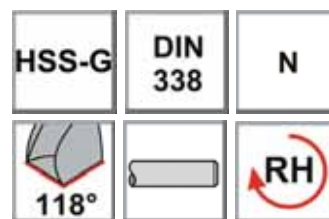

Broj artikla		Ø d-mm	L2 mm	L1 mm	Pakovanje industrijsko		Pakovanje blister	
Pakovanje Industrijsko	Pakovanje Blister				količina po pak	cena/din po kom	količina po pak	cena/din po pak
1210360010	B	1,0	14	36	10	37,86	3	201,20
1210360011		1,1	14	36	10	37,86	*	*
1210380012		1,2	16	38	10	37,86	*	*
1210380013		1,3	16	38	10	37,86	*	*
1210400014		1,4	18	40	10	37,86	*	*
1210400015	B	1,5	18	40	10	37,86	3	183,73
1210430016		1,6	20	43	10	37,86	*	*
1210430017		1,7	20	43	10	37,86	*	*
1210460018		1,8	22	46	10	37,86	*	*
1210460019		1,9	22	46	10	37,86	*	*
1210490020	B	2,0	24	49	10	37,86	3	183,73
1210490021		2,1	24	49	10	37,86	*	*
1210530022		2,2	27	53	10	37,86	*	*
1210530023		2,3	27	53	10	37,86	*	*
1210570024		2,4	30	57	10	37,86	*	*
1210570025	B	2,5	30	57	10	37,86	3	183,73
1210570026		2,6	30	57	10	37,86	*	*
1210610027		2,7	33	61	10	37,86	*	*
1210610028		2,8	33	61	10	37,86	*	*
1210610029		2,9	33	61	10	46,24	*	*
1210610030	B	3,0	33	61	10	46,24	3	208,85
1210650031		3,1	36	65	10	58,80	*	*
1210650032	B	3,2	36	65	10	58,80	3	246,54
1210650033	B	3,3	36	65	10	58,80	3	246,54
1210700034		3,4	39	70	10	58,80	*	*
1210700035	B	3,5	39	70	10	58,80	2	187,92
1210700036		3,6	39	70	10	71,36	*	*
1210700037		3,7	39	70	10	71,36	*	*
1210750038		3,8	43	75	10	71,36	*	*
1210750039		3,9	43	75	10	71,36	*	*

# Spiralna burgija HSS -G brušena - svetla

Krstasto brušena burgija za univerzalno korišćenje za obradu čelika do 950 N/mm<sup>2</sup>

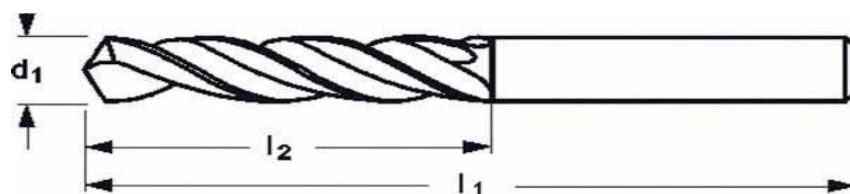

# PTG

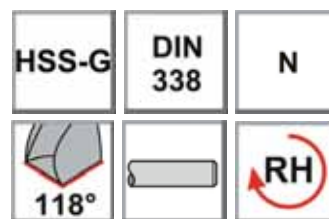

Broj artikla		Ø d-mm	L2 mm	L1 mm	Pakovanje industrijsko		Pakovanje blister	
Pakovanje Industrijsko	Blister				količina po pak	cena/din po kom	količina po pak	cena/din po pak
1210750040	B	4,0	43	75	10	71,36	2	183,73
1210750041		4,1	43	75	10	83,92	*	*
1210750042	B	4,2	43	75	10	83,92	2	238,16
1210800043		4,3	47	80	10	83,92	*	*
1210800044		4,4	47	80	10	83,92	*	*
1210800045	B	4,5	47	80	10	83,92	2	238,16
1210800046		4,6	47	80	10	96,48	*	*
1210800047		4,7	47	80	10	96,48	*	*
1210860048		4,8	52	86	10	96,48	*	*
1210860049		4,9	52	86	10	96,48	*	*
1210860050	B	5,0	52	86	10	96,48	2	263,28
1210860051		5,1	52	86	10	109,04	*	*
1210860052		5,2	52	86	10	109,04	*	*
1210860053		5,3	52	86	10	109,04	*	*
1210930054		5,4	57	93	10	109,04	*	*
1210930055	B	5,5	57	93	10	109,04	2	288,41
1210930056		5,6	57	93	10	121,60	*	*
1210930057		5,7	57	93	10	121,60	*	*
1210930058		5,8	57	93	10	121,60	*	*
1210930059		5,9	57	93	10	121,60	*	*
1210930060	B	6,0	57	93	10	121,60	2	313,53
1211010061		6,1	63	101	10	129,97	*	*
1211010062		6,2	63	101	10	129,97	*	*
1211010063		6,3	63	101	10	129,97	*	*
1211010064		6,4	63	101	10	129,97	*	*
1211010065	B	6,5	63	101	10	129,97	1	204,11
1211010066		6,6	63	101	10	155,10	*	*
1211010067		6,7	63	101	10	155,10	*	*
1211090068	B	6,8	69	109	10	155,10	1	229,23
1211090069		6,9	69	109	10	155,10	*	*

# Spiralna burgija HSS -G brušena - svetla

Krstasto brušena burgija za univerzalno korišćenje za obradu čelika do 950 N/mm<sup>2</sup>

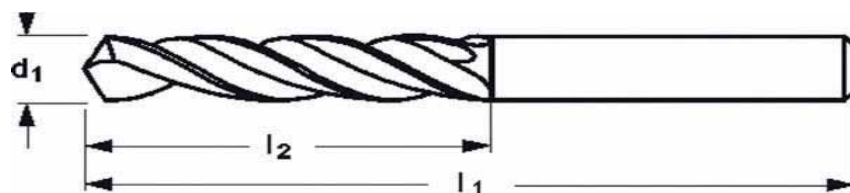

# PTG

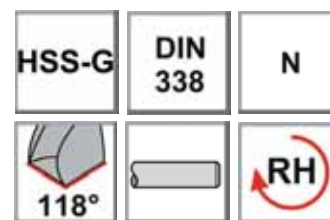

Broj artikla	Pakovanje		Ø d-mm	L2 mm	L1 mm	Pakovanje industrijsko		Pakovanje blister	
	Industrijsko	Blister				količina po pak	cena/din po kom	količina po pak	cena/din po pak
1211090070	B		7,0	69	109	10	155,10	1	229,23
1211090071			7,1	69	109	10	180,22	*	*
1211090072			7,2	69	109	10	180,22	*	*
1211090073			7,3	69	109	10	180,22	*	*
1211090074			7,4	69	109	10	180,22	*	*
1211090075	B		7,5	69	109	5	180,22	1	254,35
1211170076			7,6	75	117	5	201,15	*	*
1211170077			7,7	75	117	5	201,15	*	*
1211170078			7,8	75	117	5	201,15	*	*
1211170079			7,9	75	117	5	201,15	*	*
1211170080	B		8,0	75	117	5	201,15	1	275,28
1211170081			8,1	75	117	5	226,27	*	*
1211170082			8,2	75	117	5	226,27	*	*
1211170083			8,3	75	117	5	226,27	*	*
1211170084			8,4	75	117	5	226,27	*	*
1211170085	B		8,5	75	117	5	226,27	1	300,40
1211250086			8,6	81	125	5	263,95	*	*
1211250087			8,7	81	125	5	263,95	*	*
1211250088			8,8	81	125	5	263,95	*	*
1211250089			8,9	81	125	5	263,95	*	*
1211250090	B		9,0	81	125	5	263,95	1	338,09
1211250091			9,1	81	125	5	284,89	*	*
1211250092			9,2	81	125	5	284,89	*	*
1211250093			9,3	81	125	5	284,89	*	*
1211250094			9,4	81	125	5	284,89	*	*
1211250095	B		9,5	81	125	5	284,89	1	359,02
1211330096			9,6	87	133	5	322,57	*	*
1211330097			9,7	87	133	5	322,57	*	*
1211330098			9,8	87	133	5	322,57	*	*
1211330099			9,9	87	133	5	322,57	*	*

# Spiralna burgija HSS -G brušena - svetla

Krstasto brušena burgija za univerzalno korišćenje za obradu čelika do 950 N/mm<sup>2</sup>



# PTG

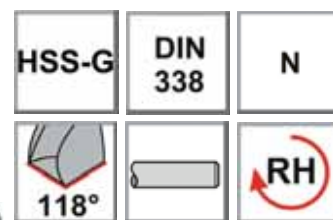

Broj artikla	Pakovanje		Ø d-mm	L2 mm	L1 mm	Pakovanje industrijsko		Pakovanje blister	
	Industrijsko	Blister				količina po pak	cena/din po kom	količina po pak	cena/din po pak
1211330100		B	10,0	87	133	5	322,57	1	396,70
1211330101			10,1	87	133	5	347,69	*	*
1211330102		B	10,2	87	133	5	347,69	1	421,82
1211330103			10,3	87	133	5	347,69	*	*
1211330104			10,4	87	133	5	347,69	*	*
1211330105		B	10,5	87	133	5	347,69	1	421,82
1211330106			10,6	87	133	5	418,87	*	*
1211420107			10,7	94	142	5	418,87	*	*
1211420108			10,8	94	142	5	418,87	*	*
1211420109			10,9	94	142	5	418,87	*	*
1211420110		B	11,0	94	142	5	418,87	1	493,00
1211420112			11,2	94	142	5	464,92	*	*
1211420115		B	11,5	94	142	5	464,92	1	539,06
1211420118			11,8	94	142	5	515,17	*	*
1211510120		B	12,0	101	151	5	515,17	1	589,30
1211510122			12,2	101	151	5	548,66	*	*
1211510125		B	12,5	101	151	5	548,66	1	622,79
1211510128			12,8	101	151	5	598,90	*	*
1211510130		B	13,0	101	151	5	598,90	1	673,04
1211600135			13,5	108	160	1	*	*	883,45
1211600140			14,0	108	160	1	*	*	932,66
1211690145			14,5	114	169	1	*	*	1.035,16
1211690150			15,0	114	169	1	*	*	1.084,37
1211780155			15,5	120	178	1	*	*	1.211,47
1211780160			16,0	120	178	1	*	*	1.260,68

# Spiralna burgija HSS super - G brušena - svetla

Krstasto brušena burgija za univerzalno korišćenje stubne i ručne mašine za obradu čelika do 1050 N/mm<sup>2</sup>

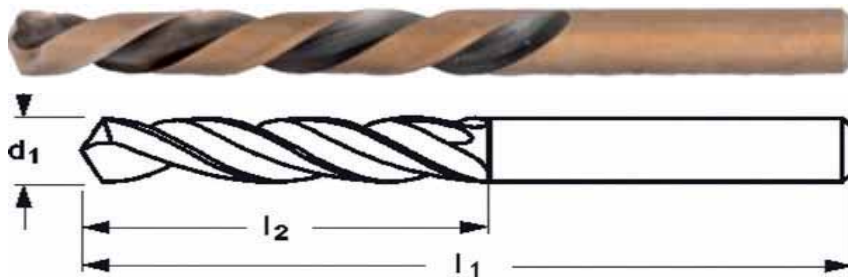

## PTG

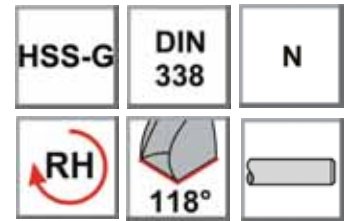

Broj artikla	Ø d - mm	L2 mm	L1 mm	Pakovanje u blisteru sadrži	Cena/din po/pak
PTG338020100	1,0	14	36	3	201,45
PTG338020150	1,5	18	40	3	191,43
PTG338020200	2,0	24	49	3	202,37
PTG338020250	2,5	30	57	3	209,08
PTG338020300	3,0	33	61	3	259,10
PTG338020320	3,2	36	65	3	271,66
PTG338020330	3,3	36	65	3	296,78
PTG338020350	3,5	39	70	2	221,42
PTG338020400	4,0	43	75	2	246,54
PTG338020420	4,2	43	75	2	254,91
PTG338020450	4,5	47	80	2	271,66
PTG338020500	5,0	52	86	2	296,78
PTG338020550	5,5	57	93	2	330,27
PTG338020600	6,0	57	93	2	363,77
PTG338020650	6,5	63	101	1	262,72
PTG338020680	6,8	63	101	1	292,03
PTG338020700	7,0	69	109	1	292,03
PTG338020750	7,5	69	109	1	317,15
PTG338020800	8,0	75	117	1	350,65
PTG338020850	8,5	75	117	1	384,14
PTG338020900	9,0	81	125	1	426,01
PTG338020950	9,5	81	125	1	455,32
PTG338021000	10,0	87	133	1	534,87
PTG338021020	10,2	87	133	1	593,49
PTG338021050	10,5	87	133	1	593,49
PTG338021100	11,0	94	142	1	664,66
PTG338021150	11,5	94	142	1	710,72
PTG338021200	12,0	101	151	1	794,46
PTG338021250	12,5	101	151	1	844,70
PTG338021300	13,0	101	151	1	894,94

# Spiralna brušena burgija sa 5% Co HSS - Co

Krstasto brušena kobaltna burgija za bušenje do 1100 N/mm<sup>2</sup>

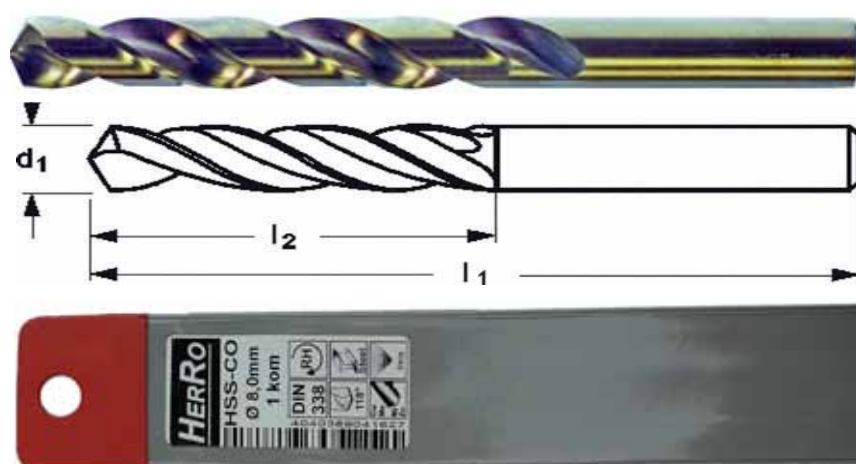

**HERRO**  
A U S T R I A

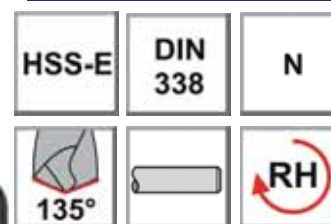

Broj artikla	Pakovanje		Ø d-mm	L2 mm	L1 mm	Pakovanje industrijsko		Pakovanje blister	
	Industrijsko	Blister				količina po pak	cena/din po kom	količina po pak	cena/din po pak
1300360010		B	1,0	14	36	10	46,24	3	208,85
1300360011			1,1	14	36	10	46,24	*	*
1300380012			1,2	16	38	10	46,24	*	*
1300380013			1,3	16	38	10	46,24	*	*
1300400014			1,4	18	40	10	46,24	*	*
1300400015		B	1,5	18	40	10	46,24	3	208,85
1300430016			1,6	20	43	10	58,80	*	*
1300430017			1,7	20	43	10	58,80	*	*
1300460018			1,8	22	46	10	58,80	*	*
1300460019			1,9	22	46	10	58,80	*	*
1300490020		B	2,0	24	49	10	58,80	3	246,54
1300490021			2,1	24	49	10	71,36	*	*
1300530022			2,2	27	53	10	71,36	*	*
1300530023			2,3	27	53	10	71,36	*	*
1300570024			2,4	30	57	10	71,36	*	*
1300570025		B	2,5	30	57	10	71,36	3	284,22
1300570026			2,6	30	57	10	83,92	*	*
1300610027			2,7	33	61	10	83,92	*	*
1300610028			2,8	33	61	10	83,92	*	*
1300610029			2,9	33	61	10	83,92	*	*
1300610030		B	3,0	33	61	10	83,92	3	321,90
1300650031			3,1	36	65	10	109,04	*	*
1300650032		B	3,2	36	65	10	109,04	3	397,26
1300650033		B	3,3	36	65	10	109,04	3	397,26
1300700034			3,4	39	70	10	109,04	*	*
1300700035		B	3,5	39	70	10	109,04	2	288,41
1300700036			3,6	39	70	10	142,54	*	*
1300700037			3,7	39	70	10	142,54	*	*
1300750038			3,8	43	75	10	142,54	*	*
1300750039			3,9	43	75	10	142,54	*	*
1300750040		B	4,0	43	75	10	142,54	2	355,40
1300750041			4,1	43	75	10	155,10	*	*
1300750042		B	4,2	43	75	10	155,10	2	380,52
1300800043			4,3	47	80	10	167,66	*	*

# Spiralna brušena burgija sa 5% Co HSS - Co

Krstasto brušena kobaltna burgija za bušenje do 1100 N/mm<sup>2</sup>

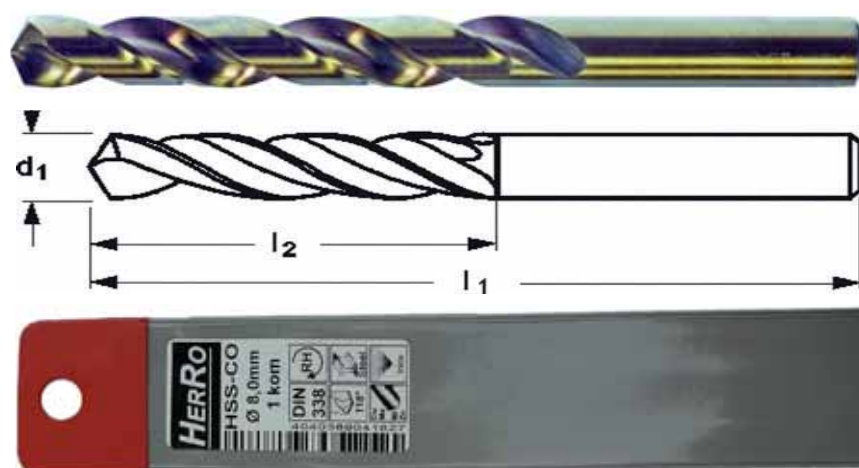

**HERRO**  
AUSTRIA

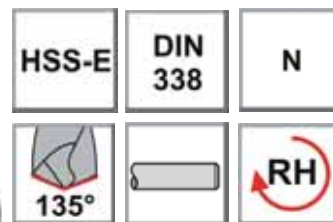

Broj artikla		Ø d-mm	L2 mm	L1 mm	Pakovanje industrijsko		Pakovanje blister	
Pakovanje Industrijsko	Blister				količina po pak	cena/din po kom	količina po pak	cena/din po pak
1300800044		4,4	47	80	10	167,66	*	*
1300800045	B	4,5	47	80	10	167,66	2	405,64
1300800046		4,6	47	80	10	192,78	*	*
1300800047		4,7	47	80	10	192,78	*	*
1300860048		4,8	52	86	10	192,78	*	*
1300860049		4,9	52	86	10	201,15	*	*
1300860050	B	5,0	52	86	10	201,15	2	472,62
1300860051		5,1	52	86	10	238,83	*	*
1300860052		5,2	52	86	10	238,83	*	*
1300860053		5,3	52	86	10	238,83	*	*
1300930054		5,4	57	93	10	238,83	*	*
1300930055	B	5,5	57	93	10	238,83	2	547,99
1300930056		5,6	57	93	10	276,52	*	*
1300930057		5,7	57	93	10	276,52	*	*
1300930058		5,8	57	93	10	276,52	*	*
1300930059		5,9	57	93	10	276,52	*	*
1300930060	B	6,0	57	93	10	276,52	2	623,36
1301010061		6,1	63	101	10	310,01	*	*
1301010062		6,2	63	101	10	310,01	*	*
1301010063		6,3	63	101	10	310,01	*	*
1301010064		6,4	63	101	10	322,57	*	*
1301010065	B	6,5	63	101	10	322,57	1	396,70
1301010066		6,6	63	101	10	393,75	*	*
1301010067		6,7	63	101	10	393,75	*	*
1301090068	B	6,8	69	109	10	393,75	1	467,88
1301090069		6,9	69	109	10	393,75	*	*
1301090070	B	7,0	69	109	10	393,75	1	467,88
1301090071		7,1	69	109	10	452,36	*	*
1301090072		7,2	69	109	10	452,36	*	*
1301090073		7,3	69	109	10	452,36	*	*
1301090074		7,4	69	109	10	452,36	*	*
1301090075	B	7,5	69	109	5	452,36	1	526,50
1301170076		7,6	75	117	5	523,54	*	*
1301170077		7,7	75	117	5	523,54	*	*

# Spiralna brušena burgija sa 5% Co HSS - Co

Krstasto brušena kobaltna burgija za bušenje do 1100 N/mm<sup>2</sup>

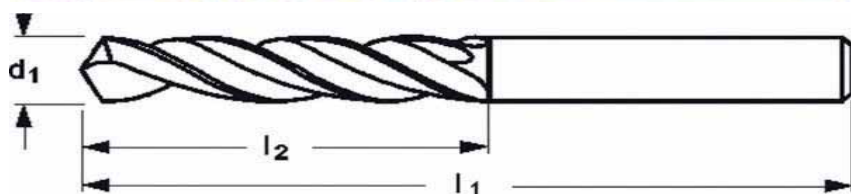

**HERRO**  
AUSTRIA

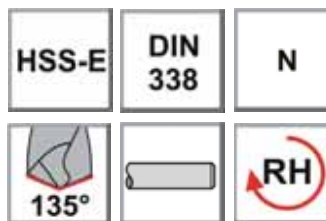

Broj artikla	Pakovanje	Ø d-mm	L2 mm	L1 mm	Pakovanje industrijsko		Pakovanje blister	
					količina po pak	cena/din po kom	količina po pak	cena/din po pak
1301170078		7,8	75	117	5	523,54	*	*
1301170079		7,9	75	117	5	523,54	*	*
1301170080	B	8,0	75	117	5	523,54	1	597,67
1301170081		8,1	75	117	5	573,78	*	*
1301170082		8,2	75	117	5	573,78	*	*
1301170083		8,3	75	117	5	573,78	*	*
1301170084		8,4	75	117	5	573,78	*	*
1301170085	B	8,5	75	117	5	573,78	1	647,91
1301250086		8,6	81	125	5	678,46	*	*
1301250087		8,7	81	125	5	678,46	*	*
1301250088		8,8	81	125	5	678,46	*	*
1301250089		8,9	81	125	5	678,46	*	*
1301250090	B	9,0	81	125	5	678,46	1	752,59
1301250091		9,1	81	125	5	753,82	*	*
1301250092		9,2	81	125	5	753,82	*	*
1301250093		9,3	81	125	5	753,82	*	*
1301250094		9,4	81	125	5	753,82	*	*
1301250095	B	9,5	81	125	5	753,82	1	827,95
1301330096		9,6	87	133	5	858,49	*	*
1301330097		9,7	87	133	5	858,49	*	*
1301330098		9,8	87	133	5	858,49	*	*
1301330099		9,9	87	133	5	858,49	*	*
1301330100	B	10,0	87	133	5	858,49	1	932,62
1301330102	B	10,2	87	133	5	954,79	1	1.028,92
1301330105	B	10,5	87	133	5	954,79	1	1.028,92
1301420110	B	11,0	94	142	5	1.097,14	1	1.171,27
1301420115	B	11,5	94	142	5	1.193,44	1	1.267,57
1301510120	B	12,0	101	151	1	1.360,92	1	1.435,05
1301510125	B	12,5	101	151	1	1.469,77	1	1.543,91
1301510130	B	13,0	101	151	1	1.574,45	1	1.648,58
1301600135		13,5	108	160	1	*	*	1.561,89
1301600140		14,0	108	160	1	*	*	1.561,89

# Spiralna burgija sa koničnom drškom

Valjana burgija za industrijske potrebe do 900 N/mm<sup>2</sup>

Broj artikla	Ø d - mm	L2 mm	L1 mm	MK	Pak-ovanje Sadržji	Cena/din po/kom
1801330050	5,0	52	133	MK 1	1	942,23
1801380055	5,5	57	138	MK 1	1	942,23
1801380060	6,0	57	138	MK 1	1	804,06
1801440065	6,5	63	144	MK 1	1	825,00
1801500070	7,0	69	150	MK 1	1	825,00
1801500075	7,5	69	150	MK 1	1	808,25
1801560080	8,0	75	156	MK 1	1	691,02
1801560085	8,5	75	156	MK 1	1	691,02
1801620090	9,0	81	162	MK 1	1	691,02
1801620095	9,5	81	162	MK 1	1	691,02
1801680100	10,0	87	168	MK 1	1	691,02
1801680102	10,2	87	168	MK 1	1	691,02
1801680105	10,5	87	168	MK 1	1	691,02
1801750110	11,0	94	175	MK 1	1	691,02
1801750115	11,5	94	175	MK 1	1	691,02
1801820120	12,0	101	182	MK 1	1	720,32
1801820125	12,5	101	182	MK 1	1	720,32
1801820130	13,0	101	182	MK 1	1	783,13
1801890135	13,5	108	189	MK 1	1	783,13
1801890140	14,0	108	189	MK 1	1	871,05
1802120145	14,5	114	212	MK 2	1	946,42
1802120150	15,0	114	212	MK 2	1	946,42
1802180155	15,5	120	218	MK 2	1	946,42
1802180160	16,0	120	218	MK 2	1	1.013,41
1802230165	16,5	125	223	MK 2	1	1.084,58
1802230170	17,0	125	223	MK 2	1	1.155,76
1802280175	17,5	130	228	MK 2	1	1.155,76
1802280180	18,0	130	228	MK 2	1	1.222,75
1802330185	18,5	135	233	MK 2	1	1.222,75
1802330190	19,0	135	233	MK 2	1	1.293,93
1802380195	19,5	140	238	MK 2	1	1.293,93
1802380200	20,0	140	238	MK 2	1	1.503,27
1802430205	20,5	145	243	MK 2	1	1.578,63
1802430210	21,0	145	243	MK 2	1	1.787,98
1802480215	21,5	150	248	MK 2	1	1.787,98
1802480220	22,0	150	248	MK 2	1	1.854,97
1802530225	22,5	155	253	MK 2	1	1.854,97
1802530230	23,0	155	253	MK 2	1	2.064,31
1802760235	23,5	155	276	MK 3	1	2.344,83
1802810240	24,0	160	281	MK 3	1	2.344,83
1802810245	24,5	160	281	MK 3	1	2.344,83
1802810250	25,0	160	281	MK 3	1	2.416,01
1802860255	25,5	165	286	MK 3	1	2.416,01
1802860260	26,0	165	286	MK 3	1	2.901,69
1802860265	26,5	165	286	MK 3	1	2.901,69

# PTG

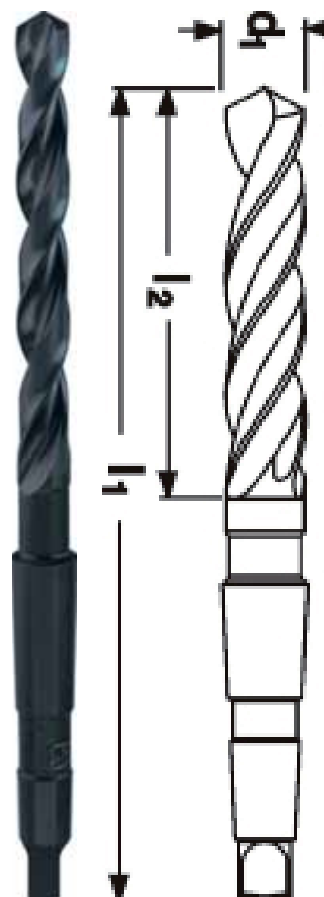
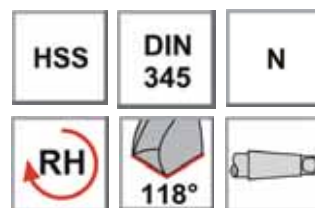

**Ručno ostrugane  
burgije veličine od**

20-25 su 6 €      30,5-35 su 8 €  
25,5-30 su 7 €      35,5-40 su 9 €

Smanjujemo burgije na  
16mm, 13mm, 10mm  
po zahtevu i na 80mm

# Spiralna burgija sa koničnom drškom

Valjana burgija za industrijske potrebe do 900 N/mm<sup>2</sup>

Broj artikla	Ø d - mm	L2 mm	L1 mm	MK	Pakovanje Sadržji	Cena/din po/kom
1802910270	27,0	170	291	MK 3	1	2.972,86
1802910275	27,5	170	291	MK 3	1	2.972,86
1802910280	28,0	170	291	MK 3	1	3.111,03
1802960285	28,5	175	296	MK 3	1	3.111,03
1802960290	29,0	175	296	MK 3	1	3.529,72
1802960295	29,5	175	296	MK 3	1	3.529,72
1802960300	30,0	175	296	MK 3	1	4.090,76
1803010305	30,5	180	301	MK 3	1	4.090,76
1803010310	31,0	180	301	MK 3	1	4.136,81
1803010315	31,5	180	301	MK 3	1	4.375,47
1803340320	32,0	185	334	MK 4	1	4.727,16
1803340325	32,5	185	334	MK 4	1	5.246,34
1803340330	33,0	185	334	MK 4	1	5.284,02
1803340335	33,5	185	334	MK 4	1	5.459,87
1803390340	34,0	190	339	MK 4	1	5.510,11
1803390345	34,5	190	339	MK 4	1	5.740,39
1803390350	35,0	190	339	MK 4	1	5.740,39
1803390355	35,5	190	339	MK 4	1	6.025,09
1803440360	36,0	195	344	MK 4	1	6.025,09
1803440365	36,5	195	344	MK 4	1	6.401,91
1803440370	37,0	195	344	MK 4	1	6.401,91
1803440375	37,5	195	344	MK 4	1	6.715,93
1803490380	38,0	200	349	MK 4	1	6.715,93
1803490385	38,5	200	349	MK 4	1	7.084,37
1803490390	39,0	200	349	MK 4	1	7.084,37
1803490395	39,5	200	349	MK 4	1	7.256,04
1803490400	40,0	200	349	MK 4	1	7.256,04

## PTG

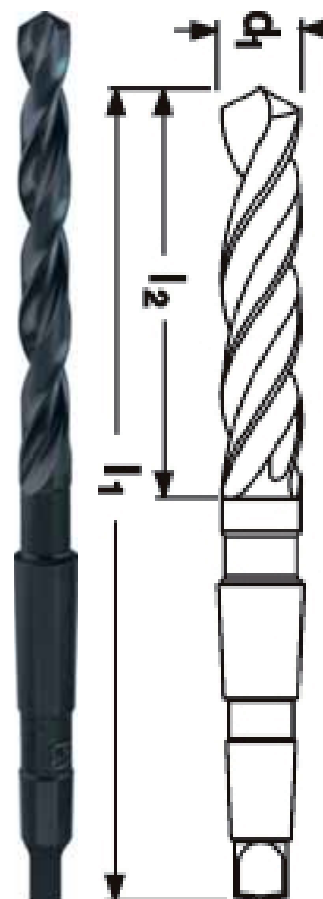
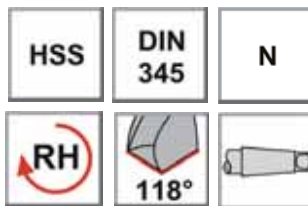

## Reducir čaure

Kaljene, brušeni unutrašnji i spoljni konusi za prilagođavanje različitih prihvata na mašinama i alatima

Broj artikla	MK spoljni/ unutrašnji K/K1	L mm	Težina Kg	Pakovanje	Cena/din po/kom
8305002001	2/1	92	0,10	1	1.164,13
8305003001	3/1	99	0,25	1	1.411,16
8305003002	3/2	112	0,19	1	1.394,41
8305004001	4/1	124	0,55	1	2.093,62
8305004002	4/2	124	0,48	1	2.093,62
8305004003	4/3	140	0,36	1	2.093,62
8305005003	5/3	156	1,36	1	3.722,13
8305005004	5/4	171	0,95	1	3.722,13

## PTG



# Spiralna burgija L HSS - G brušena - DIN 338

Ekstra kratka brušena burgija sa pojačanim srednjim delom, za bušenje u teškim uslovima 950 N/mm<sup>2</sup>

# PTG

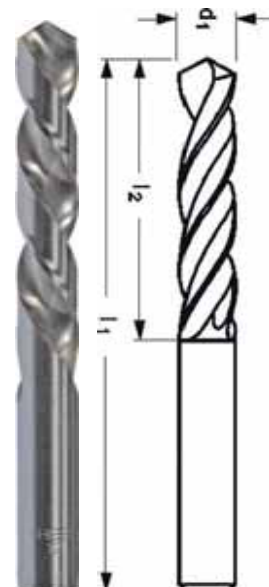

Broj artikla	Ø d - mm	L2 - mm	L1 - mm	Jedno Pakovanje Sadrži	Cena/din po/kom
1010360010	1,0	14	36	1	113,23
1010400015	1,5	18	40	1	125,79
1010490020	2,0	24	49	1	138,35
1010570025	2,5	30	57	1	150,91
1010610030	3,0	33	61	1	201,15
1010700035	3,5	39	70	1	238,83
1010750040	4,0	43	75	1	263,95
1010800045	4,5	47	80	1	326,76
1010860050	5,0	52	86	1	364,44
1010930055	5,5	57	93	1	427,24
1010930060	6,0	57	93	1	452,36
1010010065	6,5	63	101	1	552,85
1010090070	7,0	69	109	1	691,02
1010090075	7,5	69	109	1	879,43
1010170080	8,0	75	117	1	1.005,03
1010170085	8,5	75	117	1	1.130,64
1010250090	9,0	81	125	1	1.256,24
1010250095	9,5	81	125	1	1.381,85
1010330100	10,0	87	133	1	1.633,06

## Burgija za varne tačke, za karoseriju kola

HSS - CO, kobaltna burgija sa ( 5% Co )



Broj artikla	Ø d - mm	L2 mm	L1 mm	Pakovanje Sadrži	Cena/din po/kom
1710660060	6,0	66	28	1	581,69
1710790080	8,0	79	37	1	975,54
1710890100	10,0	89	43	1	1.551,17

## Set bit burgija HSS titanijum

Set burgija za punktiranje, 10 komada

Broj artikla	Ø d - mm	Jedno Pakovanje Sadrži	Cena/din po/kom
B1632	1,5 - 10	10	288,84



# Spiralna burgija HSS - G brušena

## Spiralna burgija PU za panele

Broj artikla	Ø d - mm	L2 mm	L1 mm	Pak- ovanje Sadrži	Cena/din po/kom
1211000030	3,0	100	30	10	189,32
1211000049	4,9	70	30	10	151,63
1211200049	4,9	100	30	10	227,00
1211500049	4,9	120	30	10	277,24
1210700049	4,9	150	30	10	352,60
1211000051	5,0	70	30	10	151,63
1211200051	5,0	100	30	10	227,00
1211500051	5,0	150	30	10	352,60
1211800051	5,0	180	30	10	503,33
1212100051	5,0	210	30	10	553,57
1210700051	5,1	70	30	10	201,88
1211000053	5,1	100	30	10	296,08
1211200053	5,1	120	30	10	371,44
1211500053	5,1	150	30	10	453,09
1211800053	5,1	180	30	10	622,66
1212100053	5,1	210	30	10	741,98
1210700053	5,3	70	30	10	201,88
1211000055	5,3	100	30	10	296,08
1211200055	5,3	120	30	10	371,44
1211500055	5,3	150	30	10	453,09
1211800055	5,3	180	30	10	622,66
1212100055	5,3	210	30	10	741,98
1210700055	5,5	70	30	10	201,88
1211000057	5,5	100	30	10	296,08
1211200057	5,5	120	30	10	371,44
1211500057	5,5	150	30	10	453,09
1211800057	5,5	180	30	10	622,66
1212100057	5,5	210	30	10	741,98
1210700057	5,7	70	30	10	227,00
1211000058	5,7	100	30	10	327,48
1211200058	5,7	120	30	10	415,41
1211500058	5,7	150	30	10	515,89
1211800058	5,7	180	30	10	704,30
1212100058	5,7	210	30	10	829,91
1210700050	5,8	70	30	10	227,00
1210700058	5,8	100	30	10	327,48
1211000050	5,8	120	30	10	415,41
1211500050	5,8	150	30	10	515,89
1211800050	5,8	180	30	10	704,30
1212100050	5,8	210	30	10	829,91

# PTG

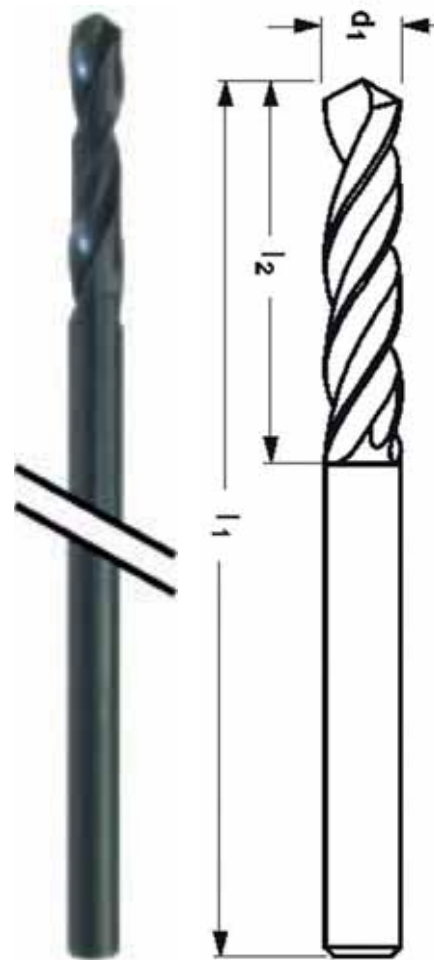

# Spiralna burgija sa dugim paralelnim prihvatom

Produžena krstasto brušena  
burgija za bušenje 950 N/mm<sup>2</sup>

Broj artikla	Ø d - mm	L2 mm	L1 mm	Pakovanje Sadrži	Cena/din po/kom
1210560010	1,0	33	56	10	71,36
1210700015	1,5	45	70	10	71,36
1210850020	2,0	56	85	10	71,36
1210950025	2,5	62	95	10	83,92
1211000030	3,0	66	100	10	96,48
1211060031	3,1	69	106	10	109,04
1211060032	3,2	69	106	10	109,04
1211060033	3,3	69	106	10	146,72
1211120035	3,5	73	112	10	109,04
1211190040	4,0	78	119	10	142,54
1211190041	4,1	78	119	10	201,15
1211190042	4,2	78	119	10	201,15
1211260045	4,5	82	126	10	201,15
1211320048	4,8	87	132	10	226,27
1211320050	5,0	87	132	10	226,27
1211320051	5,1	87	132	10	263,95
1211320052	5,2	87	132	10	263,95
1211390055	5,5	91	139	10	263,95
1211390058	5,8	91	139	10	297,45
1211390060	6,0	91	139	10	297,45
1211480065	6,5	97	148	10	343,51
1211560068	6,8	102	156	10	393,75
1211560070	7,0	102	156	10	393,75
1211560075	7,5	102	156	5	431,43
1211650080	8,0	109	165	5	464,92
1211650082	8,2	109	165	5	536,10
1211650085	8,5	109	165	5	536,10
1211750090	9,0	115	175	5	573,78
1211750095	9,5	115	175	5	598,90
1211840100	10,0	121	184	5	703,58
1211840102	10,2	121	184	5	812,44
1211840105	10,5	121	184	5	812,44
1211950110	11,0	128	195	5	954,79
1211950115	11,5	128	195	5	1.013,41
1212050120	12,0	134	205	5	1.076,21
1212050125	12,5	134	205	5	1.134,82
1212050130	13,0	134	205	5	1.193,44

# PTG

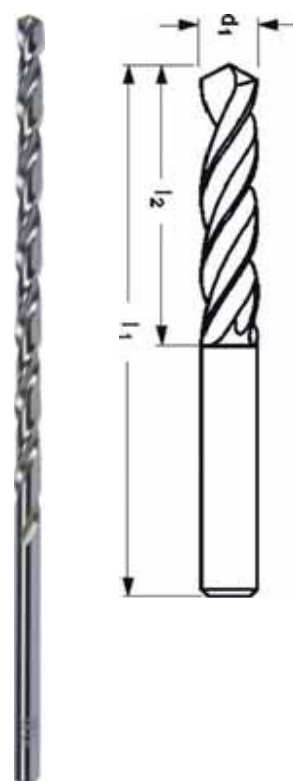
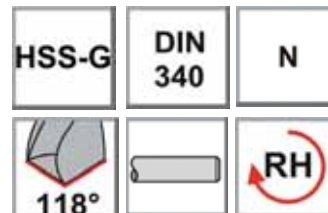

# Spiralna burgija sa dugim paralelnim prihvatom

Krstasto brušena burgija, ekstra dugačka  
po DIN1869 red 1 950 N/mm<sup>2</sup>

Broj artikla	Ø d - mm	L2 mm	L1 mm	Pakovanje Sadržai	Cena/din po/kom
1211000010	1,0	33	56	1	506,79
1211000015	1,5	45	70	1	506,79
1211250020	2,0	85	125	1	191,00
1211400025	2,5	95	140	1	209,99
1211500030	3,0	100	150	1	228,53
1211500031	3,1	100	150	1	289,08
1211550032	3,2	105	155	1	258,38
1211550033	3,3	105	155	1	318,38
1211550035	3,5	105	155	1	279,18
1211750040	4,0	120	175	1	347,46
1211750042	4,2	120	175	1	381,82
1211850045	4,5	125	185	1	416,64
1211950050	5,0	135	195	1	433,82
1212050055	5,5	140	205	1	518,38
1212050060	6,0	140	205	1	604,75
1212150065	6,5	150	215	1	692,92
1211250068	6,8	150	215	1	1151,57
1212250070	7,0	155	225	1	779,29
1212250075	7,5	155	225	1	863,85
1212400080	8,0	165	240	1	989,10
1212400085	8,5	165	240	1	1126,12
1212500090	9,0	175	250	1	1262,67
1212500095	9,5	175	250	1	1399,69
1212650100	10,0	185	265	1	1537,15
1212650105	10,5	185	265	1	1638,89
1212800110	11,0	195	280	1	1757,81
1212800115	11,5	195	280	1	1844,18
1212950120	12,0	205	295	1	1945,92
1212950125	12,5	205	295	1	2049,02
1212950130	13,0	205	295	1	2148,95

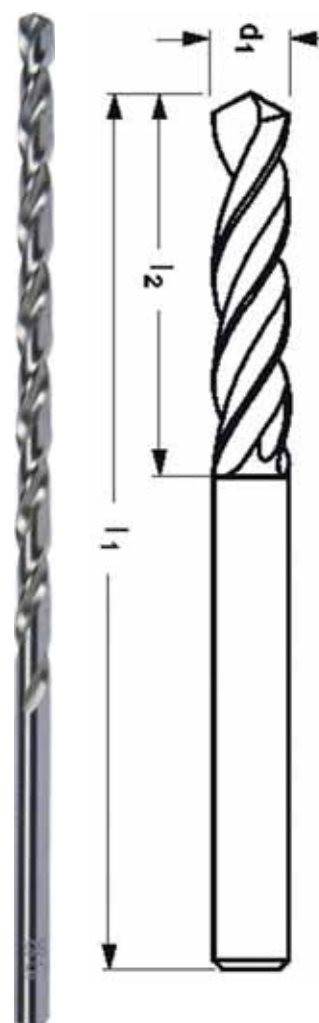
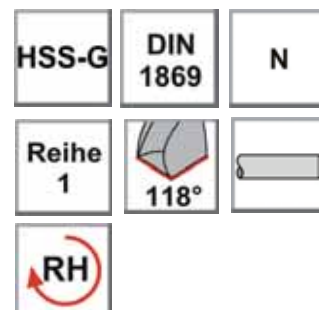

# Spiralna burgija sa dugim paralelnim prihvatom

Krstasto brušena burgija, ekstra dugačka  
po DIN1869 red 2 950 N/mm<sup>2</sup>

Broj artikla	Ø d - mm	L2 mm	L1 mm	Pakovanje Sadržji	Cena/din po/kom
1211600020	2,0	110	160	1	225,37
1211800025	2,5	120	180	1	262,90
1211900030	3,0	130	190	1	279,18
1212000032	3,2	135	200	1	305,40
1212100035	3,5	145	210	1	313,54
1212200040	4,0	150	220	1	347,46
1212200042	4,2	150	220	1	561,79
1212350045	4,5	160	235	1	774,77
1212450050	5,0	170	245	1	859,78
1212450052	5,2	170	245	1	1.116,17
1212600055	5,5	180	260	1	1.202,53
1212600060	6,0	180	260	1	1.478,82
1212750065	6,5	190	275	1	1.719,83
1212900070	7,0	200	290	1	1.769,57
1212900075	7,5	200	290	1	1.817,95
1213050080	8,0	210	305	1	1.908,84
1213050085	8,5	210	305	1	1.964,46
1213200090	9,0	220	320	1	2.014,20
1213200095	9,5	220	320	1	2.049,02
1213400100	10,0	235	340	1	2.083,39
1213400105	10,5	235	340	1	2.253,41
1213650110	11,0	250	365	1	2.427,04
1213650115	11,5	250	365	1	2.599,78
1213750120	12,0	260	375	1	2.772,51
1213750125	12,5	260	375	1	2.944,79
1213750130	13,0	260	375	1	3.108,48

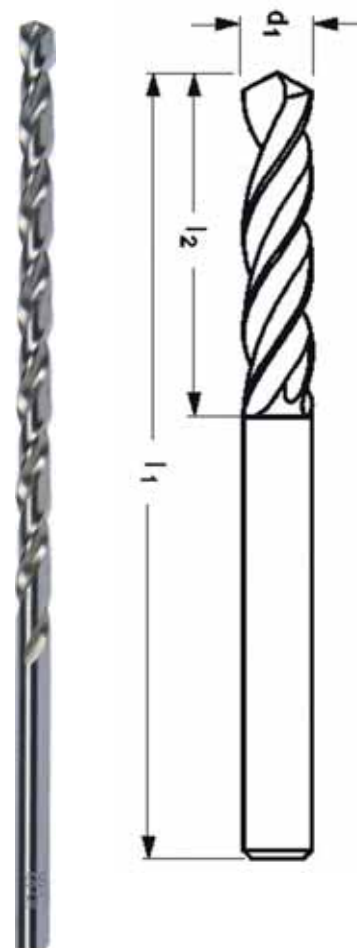
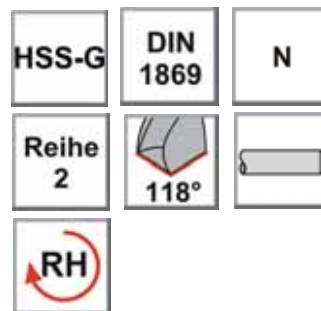

# Spiralna burgija sa dugim paralelnim prihvatom

Krstasto brušena burgija, ekstra dugačka  
po DIN1869 red 3 950 N/mm<sup>2</sup>

Broj artikla	Ø d - mm	L2 mm	L1 mm	Pakovanje Sadrži	Cena/din po/kom
121200020	2,0	135	200	1	260,19
1212250025	2,5	150	225	1	297,27
1212400030	3,0	160	240	1	313,54
1212500032	3,2	170	250	1	347,46
1212650035	3,5	180	265	1	483,56
1212800040	4,0	190	280	1	536,47
1212800042	4,2	190	280	1	586,21
1212950045	4,5	200	295	1	792,86
1213150050	5,0	210	315	1	1.031,61
1213150052	5,2	210	315	1	1.409,18
1213300055	5,5	225	330	1	1.636,18
1213300060	6,0	225	330	1	1.890,76
1213500065	6,5	235	350	1	1.981,64
1213700070	7,0	250	370	1	2.063,49
1213700075	7,5	250	370	1	2.154,38
1213900080	8,0	265	390	1	2.254,31
1213900085	8,5	265	390	1	2.345,20
1214100090	9,0	280	410	1	2.427,04
1214100095	9,5	280	410	1	2.517,93
1214300100	10,0	295	430	1	2.681,62
1214300105	10,5	295	430	1	2.954,29
1214550110	11,0	310	455	1	3.199,37
1214550115	11,5	310	455	1	3.453,95
1214800120	12,0	330	480	1	3.708,53
1214800125	12,5	330	480	1	3.963,11
1214800130	13,0	330	480	1	4.326,66

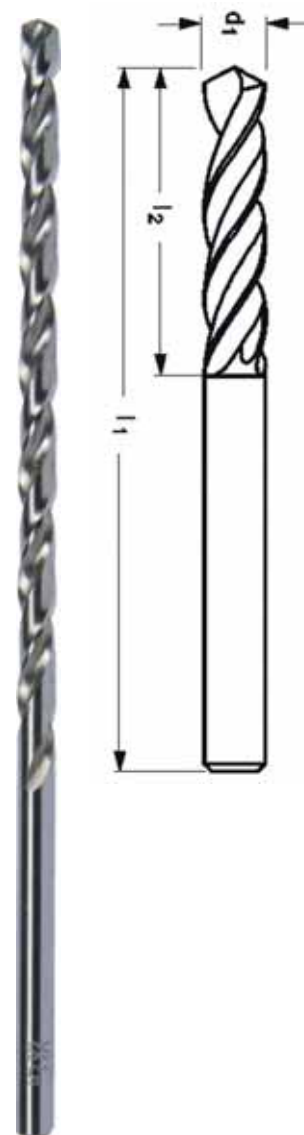
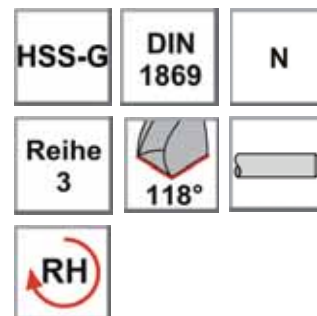

# Burgija za lim

Obostrana, ekstra kratka,  
HSS - G, desnorezna, krstasto narezana,  
850 N/mm<sup>2</sup>

Broj artikla	Ø d - mm	L2 mm	L1 mm	Pakovanje Sadrži	Cena/din po/kom
1610430025	2,5	9	43	10	136,46
1610490030	3,0	11	49	10	50,37
1610490031	3,1	11	49	10	55,80
1610490032	3,2	11	49	10	68,01
1610490033	3,3	11	49	10	68,01
1610520035	3,5	14	52	10	71,17
1610550040	4,0	14	55	10	83,84
1610550041	4,1	14	55	10	92,88
1610550042	4,2	14	55	10	98,30
1610580045	4,5	17	58	10	106,44
1610620048	4,8	17	62	10	113,68
1610620049	4,9	17	62	10	119,56
1610620050	5,0	17	62	10	124,98
1610620051	5,1	17	62	10	130,86
1610620052	5,2	17	62	10	140,81

## PTG

HSS - G	DIN 1897	N
WN	118°	RH

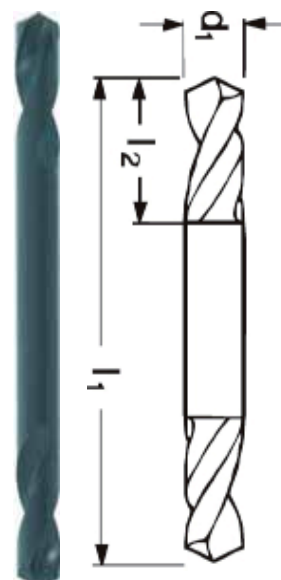

## Spiralna burgija sa smanjenim vratom

Industrijska valjana burgija za bušenje  
čelika do 900N/mm<sup>2</sup>  
valjane HSS, fabrički smanjene

Broj artikla	Ø d - mm	L2 mm	L1 mm	Pakovanje Sadrži	Cena/din po/kom
1501600135	13,5	108	160	1	331,63
1501600140	14,0	108	160	1	418,90
1501690145	14,5	114	169	1	474,07
1501690150	15,0	114	169	1	506,63
1501780155	15,5	120	178	1	567,22
1501780160	16,0	120	178	1	600,23
1501820165	16,5	125	184	1	675,29
1501860170	17,0	125	184	1	702,87
1501920175	17,5	130	191	1	805,07
1501920180	18,0	130	191	1	837,62
1501960185	18,5	135	198	1	980,51
1502000190	19,0	135	198	1	1.024,83
1502050195	19,5	140	205	1	1.141,04
1502050200	20,0	140	205	1	1.204,34

Fabrički smanjene

HSS	DIN 338	N
118°	RH	



# Setovi burgija

## Set burgija HSS - R, DIN 338

Burgija za univerzalno korišćenje kod ručne mašine za obradu čelika do 700 N/mm

Broj artikla	Ø d - mm	Jedno Pakovanje Sadrži	Cena/din po/kom
1910190110	1,0-10	19	1.330,71
1910190113	1,0-13	20	2.585,04

**PTG**



**PTG**

## Set burgija HSS - R, DIN 338

Burgija za univerzalno korišćenje kod ručne mašine za obradu čelika do 750 N/mm

Broj artikla	Ø d - mm	Jedno Pakovanje Sadrži	Cena/din po/kom
1911190110	1,0-10	19	2.034,11
1911250113	1,0-13	25	4.452,68

## Set burgija HSS - G, DIN 338

Krstasto brušena burgija za univerzalno korišćenje stubne i ručne mašine za obradu čelika do 850 N/mm<sup>2</sup>

Broj artikla	Ø d - mm	Jedno Pakovanje Sadrži	Cena/din po/kom
1920190110	1,0-10	19	2.366,75
1920250113	1,0-13	25	4.452,68

**HERRO**  
AUSTRIA



**PTG**

## Set burgija HSS - G, DIN 338

Krstasto brušena burgija za univerzalno korišćenje stubne i ručne mašine za obradu čelika do 950 N/mm<sup>2</sup>

Broj artikla	Ø d - mm	Jedno Pakovanje Sadrži	Cena/din po/kom
1922190110	1,0-10	19	2.640,48
1922250113	1,0-13	25	4.916,99

# Setovi burgija

## Set burgija HSS super - G, DIN 338

Krstasto brušena burgija za univerzalno korišćenje stubne i ručne mašine za obradu čelika do 1050 N/mm<sup>2</sup>

Broj artikla	Ø d - mm	Jedno Pakovanje Sadrži	Cena/din po/kom
PTG338027019	1,0-10	19	3.707,70
PTG338027025	1,0-13	25	7.429,11

**PTG**



**PTG**

## Setovi burgija HSS - Co, DIN 338

Krstasto brušena kobaltna burgija za bušenje do 1100 N/mm<sup>2</sup>

Broj artikla	Ø d - mm	Jedno Pakovanje Sadrži	Cena/din po/kom
1933190110	1,0-10	19	5.370,90
1933250113	1,0-13	25	11.053,50

## Set burgija SDS PLUS

Broj artikla	Ø d - mm	Jedno Pakovanje Sadrži	Cena/din po/kom
B2007	5,0-10	6	918,58



**BGS**  
technic  
WERKZEUGE

**BGS**  
technic  
WERKZEUGE



## Set burgija HSS - R

Broj artikla	Ø d - mm	Jedno Pakovanje Sadrži	Cena/din po/kom
B50808	3,0-10	8	650,00

# Setovi burgija

## Set burgija za beton Hobby

Broj artikla	Ø d - mm	Jedno Pakovanje Sadrži	Cena/din po/kom
B50807	4,0-10	5	307,25



## Set udarnih burgija

Broj artikla	Ø d - mm	Jedno Pakovanje Sadrži	Cena/din po/kom
B50816	4,0-10	5	491,36



## Set burgija za drvo

Broj artikla	Ø d - mm	Jedno Pakovanje Sadrži	Cena/din po/kom
B2017	4,0-10	5	288,84



## Set bit burgija HSS titanijum

Broj artikla	Ø d - mm	Jedno Pakovanje Sadrži	Cena/din po/kom
B50801	1,5 - 10	10	288,84

# Zabušivači



## Zabušivač HSS forma A

Broj artikla	Ø d1- mm	d2 mm	L1 mm	Pakovanje	Cena/din po/kom
7800310010	1,00	3,15	31,5	1	266,97
7800310012	1,25	3,15	31,5	1	266,97
7800350016	1,60	4,00	35,5	1	266,97
7800400020	2,00	5,00	40,0	1	266,97
7800450025	2,50	6,30	45,0	1	284,15
7800500031	3,15	8,00	50,0	1	409,41
7800560040	4,00	10,00	56,0	1	568,57
7800630050	5,00	12,50	63,0	1	816,37
7800710063	6,30	16,00	71,0	1	1.207,06
7800800080	8,00	8,00	80,0	1	3.225,54
7801000100	10,00	10,00	100,0	1	7.255,62

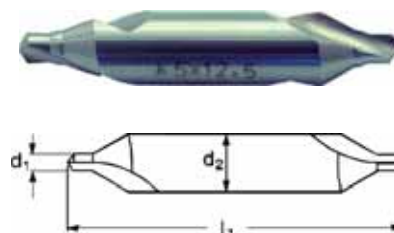
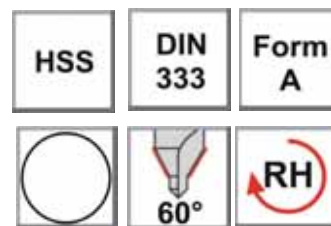

## Zabušivači



## Zabušivač HSS forma R

Broj artikla	Ø d1- mm	d2 mm	L1 mm	Pakovanje	Cena/din po/kom
7000310010	1,0	3,15	31,5	1	363,60
7000310012	1,25	3,15	31,5	1	363,60
7000350016	1,6	4,00	35,5	1	447,97
7000400020	2,0	5,00	40,0	1	473,93
7000450025	2,5	6,30	45,0	1	525,84
7000500031	3,15	8,00	50,0	1	688,08
7000560040	4,0	10,0	56,0	1	986,61
7000630050	5,0	12,50	63,0	1	1.551,21

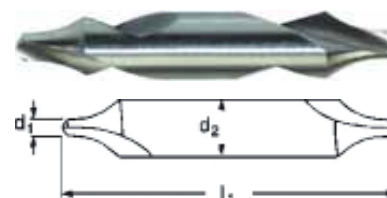
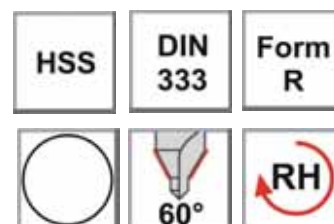

## Zabušivači



## Zabušivač HSS ekstra dugačak

Broj artikla	Ø d1- mm	d2 mm	L1 mm	Pakovanje	Cena/din po/kom
7801200016	1,6	4,00	1,60	1	947,67
7801200020	2,0	5,00	2,00	1	947,67
7801200025	2,5	6,30	2,50	1	1.012,57
7801200031	3,15	8,00	3,15	1	1.090,44
7801200040	4,0	10,00	4,00	1	1.453,86
7801200050	5,0	12,50	5,00	1	1.986,02

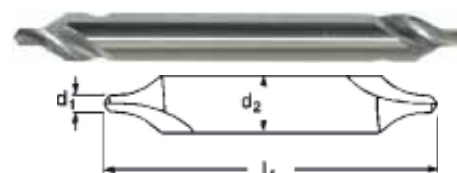
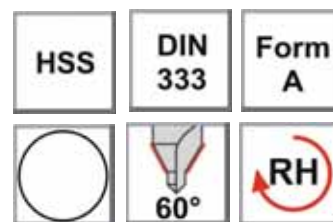

# Zabušivači

## PTG

Zabušivač HSS - TIN forma A

Broj artikla	Ø d1- mm	d2 mm	L1 mm	Pakovanje	Cena/din po/kom
7880310010	1,00	3,15	31,5	1	1.019,06
7880310012	1,25	3,15	31,5	1	1.019,06
7880350016	1,60	4,00	35,5	1	1.038,53
7880400020	2,00	5,00	40,0	1	1.077,46
7880450025	2,50	6,30	45,0	1	1.116,40
7880500031	3,15	8,00	50,0	1	1.265,66
7880560040	4,00	10,00	56,0	1	2.154,75
7880630050	5,00	12,50	63,0	1	2.959,46

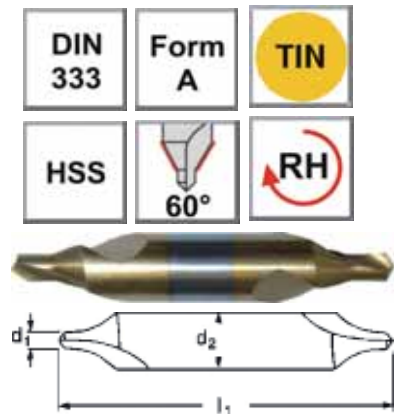

## Zabušivači

## PTG

Zabušivač HSS forma B

Broj artikla	Ø d1 - mm	d2 mm	L1 mm	Pakovanje	Cena/din po/kom
7900310010	1,00	3,2	31,5	1	688,08
7900310012	1,25	3,2	31,5	1	688,08
7900350016	1,60	4,0	35,5	1	649,15
7900400020	2,00	5,0	40,0	1	727,02
7900450025	2,50	6,3	45,0	1	1.129,38
7900500031	3,15	8,0	50,0	1	1.609,62
7900560040	4,00	10,0	56,0	1	2.894,57
7900630050	5,00	12,5	63,0	1	4.114,62

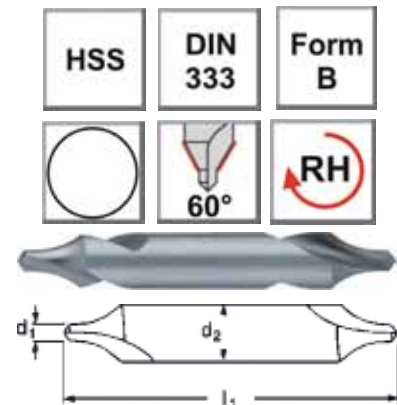

## Zabušivači

## PTG

Zabušivač HSS - Co forma A

Broj artikla	Ø d1- mm	d2 mm	L1 mm	Pakovanje	Cena/din po/kom
7890310012	1,25	3,15	31,5	1	623,19
7890350016	1,60	4,00	35,5	1	688,08
7890400020	2,00	5,00	40,0	1	798,41
7890450025	2,50	6,30	45,0	1	876,28
7890500031	3,15	8,00	50,0	1	1.038,53
7890560040	4,00	10,00	56,0	1	1.414,93
7890630050	5,00	12,50	63,0	1	2.420,82
7890710063	6,30	16,00	71,0	1	3.361,82

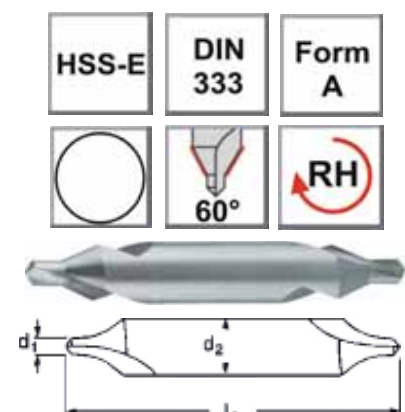

## Stepenasta burgija HSS visoki kvalitet



Broj artikla	Ø d - mm	L1 mm	Pakovanje Sadržji	Cena/din po/kom
4118880412	4-12	45	1	1.170,25
4118880420	4-20	48	1	2.079,14
4118880630	6-30	65	1	4.509,17

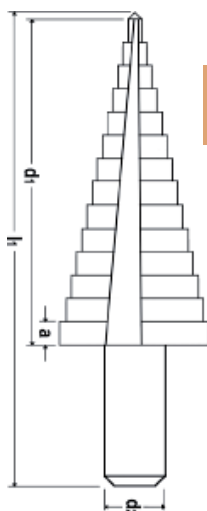
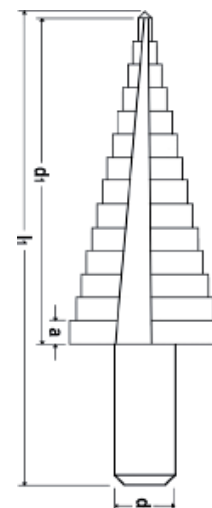

## Stepenasta burgija HSS-E visoki kvalitet



Broj artikla	Ø d - mm	L1 mm	Pakovanje Sadržji	Cena/din po/kom
4120450412	4-12	45	1	1.619,72
4120480420	4-20	48	1	2.867,75
4120650630	6-30	65	1	6.228,82

## Stepenasta burgija obložena titanom

Broj artikla	Ø d - mm	Pakovanje Sadržji	Cena/din po/kom
B1618	4-22	1	897,34
B1619	4-32	1	1.767,36



## Stepenasta burgija HSS - TIAL



Broj artikla	Ø d - mm	Pakovanje Sadržji	Cena/din po/kom
B1945-1	6-30	1	3.778,55

## Konične burgije Desnorezne, sa dva žleba



Broj artikla	Ø d - mm	Pakovanje Sadržji	Cena/din po/kom
4410550314	3-14	1	1.518,76
4410630420	5-20	1	2.647,96
4410730531	5-31	1	8.248,53
4410731630	16-30,5	1	6.249,72

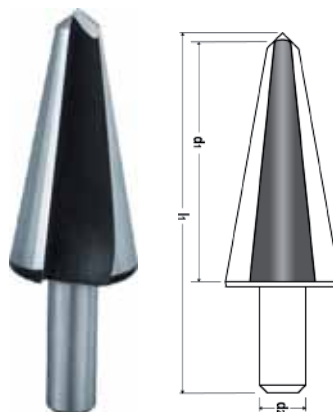

**PTG**

## Konične burgije Desnorezne, sa dva žleba

**PTG**

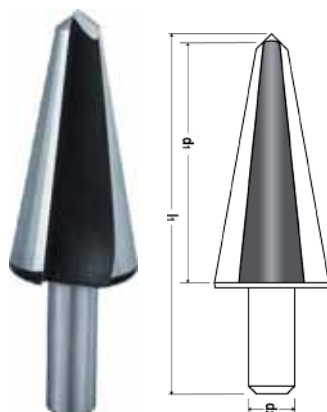

Broj artikla	Ø d - mm	Pakovanje Sadržji	Cena/din po/kom
4420550314	3-14	1	1.590,15
4420630420	5-20	1	2.745,31
4420630531	5-31	1	6.736,44
4420731630	16-30,5	1	5.912,26

## Stepenaste burgije titnijumske

Broj artikla	Ø d - mm	Jedno Pakovanje Sadržji	Cena/din po/kom
B1624	4,0-30	3	4.314,83



**BGS**  
technic  
WERKZEUGE

**BGS**  
technic  
WERKZEUGE



## Stepenaste burgije HSS - TIAL

Broj artikla	Ø d - mm	Jedno Pakovanje Sadržji	Cena/din po/kom
B1945	4,0-30	3	7.444,54

# Setovi burgija

## Set konusnih burgija

Broj artikla	Ø d - mm	Jedno Pakovanje Sadrži	Cena/din po/kom
<b>B1998</b>	3-14 8-20 16-30,5	3	<b>2.935,38</b>



## Set multi burgija

Broj artikla	Ø d - mm	Jedno Pakovanje Sadrži	Cena/din po/kom
<b>B1944</b>	4,0-30	3	<b>2.085,29</b>

## Konični upuštači HSS

Desnorezne, tipa N

Broj artikla	Ø d - mm	L1-mm	Pak- ovanje Sadrži	Cena/din po/kom
<b>4210400043</b>	4,3	40	1	<b>514,50</b>
<b>4210400050</b>	5,0	40	1	<b>514,50</b>
<b>4210450060</b>	6,0	45	1	<b>527,47</b>
<b>4210450063</b>	6,3	45	1	<b>527,47</b>
<b>4210500070</b>	7,0	50	1	<b>566,41</b>
<b>4210500080</b>	8,0	50	1	<b>689,72</b>
<b>4210500083</b>	8,3	50	1	<b>689,72</b>
<b>4210500100</b>	10,0	50	1	<b>728,65</b>
<b>4210500104</b>	10,4	50	1	<b>728,65</b>
<b>4210560115</b>	11,5	56	1	<b>890,90</b>
<b>4210560124</b>	12,4	56	1	<b>890,90</b>
<b>4210600165</b>	16,5	60	1	<b>1.721,57</b>
<b>4210630190</b>	19,0	63	1	<b>1.909,77</b>
<b>4210630205</b>	20,5	63	1	<b>2.208,30</b>
<b>4210670230</b>	23,0	67	1	<b>2.759,92</b>
<b>4210670250</b>	25,0	67	1	<b>3.038,97</b>
<b>4210710300</b>	30,0	71	1	<b>3.577,61</b>

# PTG

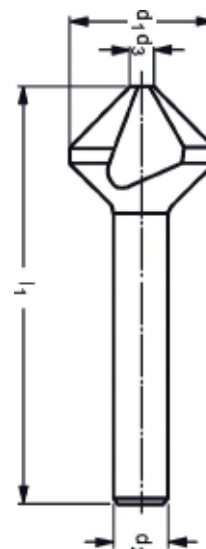

# Konični upuštači HSS-E

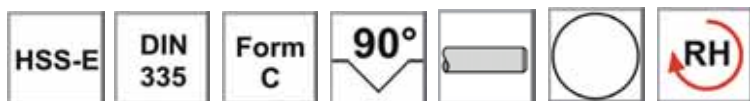

## PTG

Desnorezne, tipa N

Broj artikla	Ø d - mm	L1 mm	Pakovanje Sadržji	Cena/din po/kom
4220450063	6,3	45	1	650,78
4220500080	8,0	50	1	838,98
4220500083	8,3	50	1	838,98
4220500100	10,0	50	1	1.066,12
4220500104	10,4	50	1	1.066,12
4220560124	12,4	56	1	1.416,56
4220600165	16,5	60	1	2.130,42
4220630205	20,5	63	1	2.545,76
4220670250	25,0	67	1	3.700,92
4220710300	30,0	71	1	3.661,98



## PTG

### Bit konični upuštači HSS

Desnorezne, tipa N

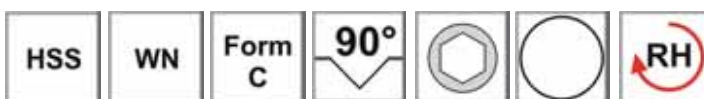
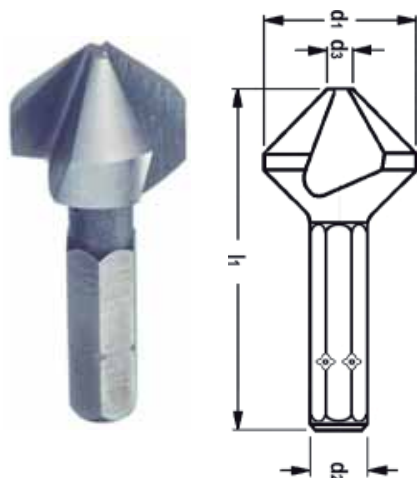

Broj artikla	Ø d - mm	L1 mm	Pakovanje Sadržji	Cena/din po/kom
4240450063	6,3	30	1	624,82
4240500083	8,3	30	1	754,61
4240500104	10,4	33	1	819,51
4240560124	12,4	35	1	1.053,14
4240600165	16,5	40	1	1.299,74
4240630205	20,5	41	1	1.494,43

### Kupasti upuštač sa rupom HSS



Broj artikla	Ø d - mm	L1 mm	Pakovanje Sadržji	Cena/din po/kom
4310450010	2-5	45	1	824,37
4310480014	5-10	48	1	2.544,13
4310650021	10-15	65	1	5.127,01
4310840028	15-20	84	1	1.2512,24

## PTG



# Udarne burgije SDS - PLUS

Burgija za bušenje sve vrste kamena i betona, za profesionalne mašine

Broj artikla	Ø d - mm	L2 mm	L1 mm	Pakovanje Sadržaj	Cena/din po/kom
2101100040	4,0	50	110	1	146,72
2101100050	5,0	50	110	1	163,47
2101100055	5,5	50	110	1	155,10
2101100060	6,0	50	110	1	159,28
2101100065	6,5	50	110	1	163,47
2101100070	7,0	50	110	1	171,84
2101100080	8,0	50	110	1	180,22
2101100100	10,0	50	110	1	196,96
2101100120	12,0	50	110	1	217,90
2101600040	4,0	100	160	1	155,10
2101600050	5,0	100	160	1	171,84
2101600060	6,0	100	160	1	192,78
2101600065	6,5	100	160	1	180,22
2101600070	7,0	100	160	1	184,40
2101600080	8,0	100	160	1	196,96
2101600090	9,0	100	160	1	209,53
2101600100	10,0	100	160	1	234,65
2101600110	11,0	100	160	1	243,02
2101600120	12,0	100	160	1	251,39
2101600130	13,0	100	160	1	305,82
2101600140	14,0	100	160	1	360,25
2101600160	16,0	100	160	1	397,93
2102100050	5,0	150	210	1	184,40
2102100060	6,0	150	210	1	222,09
2102100065	6,5	150	210	1	213,71
2102100070	7,0	150	210	1	243,02
2102100080	8,0	150	210	1	247,21
2102100090	9,0	150	210	1	255,58
2102100100	10,0	150	210	1	263,95
2102100110	11,0	150	210	1	280,70
2102100120	12,0	150	210	1	293,26
2102100130	13,0	150	210	1	351,88
2102100140	14,0	150	210	1	406,31
2102100150	15,0	150	210	1	431,43
2102100160	16,0	150	210	1	456,55
2102100180	18,0	150	210	1	577,97
2102100190	19,0	150	210	1	632,40
2102100200	20,0	150	210	1	682,64
2102100220	22,0	150	210	1	799,87
2102100250	25,0	150	210	1	975,72
2102100260	26,0	150	210	1	1.097,14
2102100280	28,0	150	210	1	1.139,01
2102100300	30,0	150	210	1	1.247,87
2102600060	6,0	200	260	1	272,33
2102600065	6,5	200	260	1	276,52

## PTG

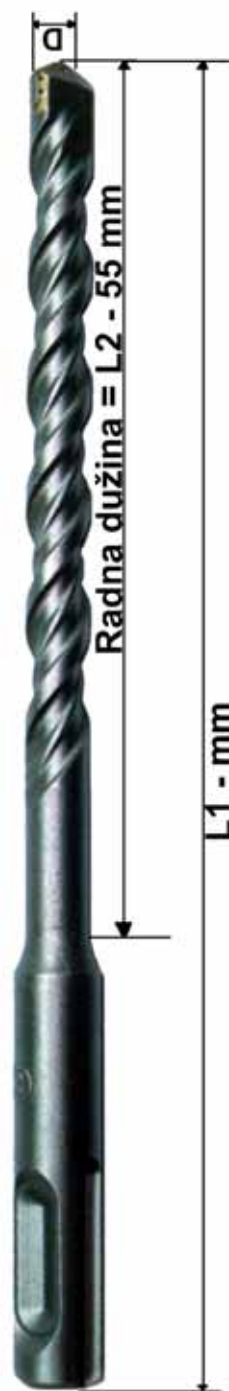

# Udarne burgije SDS - PLUS

Burgija za bušenje sve vrste kamena i betona, za profesionalne mašine

Broj artikla	Ø d - mm	L2 mm	L1 mm	Pakovanje Sadržaji	Cena/din po/kom
2102600070	7,0	200	260	1	284,89
2102600080	8,0	200	260	1	293,26
2102600100	10,0	200	260	1	314,20
2102600120	12,0	200	260	1	343,51
2102600130	13,0	200	260	1	397,93
2102600140	14,0	200	260	1	477,49
2102600160	16,0	200	260	1	557,04
2102600180	18,0	200	260	1	653,33
2102600200	20,0	200	260	1	791,50
2102600220	22,0	200	260	1	896,17
2102600240	24,0	200	260	1	1.017,59
2102600250	25,0	200	260	1	1.097,14
2102600260	26,0	200	260	1	1.210,19
2102600280	28,0	200	260	1	1.256,24
2102600300	30,0	200	260	1	1.365,10
2103100080	8,0	250	310	1	368,63
2103100100	10,0	250	310	1	389,56
2103100120	12,0	250	310	1	418,87
2103100130	13,0	250	310	1	477,49
2103100140	14,0	250	310	1	548,66
2103100160	16,0	250	310	1	632,40
2103100180	18,0	250	310	1	741,26
2103100190	19,0	250	310	1	799,87
2103100200	20,0	250	310	1	858,49
2103100220	22,0	250	310	1	1.000,84
2103100250	25,0	250	310	1	1.256,24
2103100260	26,0	250	310	1	1.348,36
2103600080	8,0	300	360	1	435,62
2103600100	10,0	300	360	1	477,49
2103600120	12,0	300	360	1	498,42
2103600130	13,0	300	360	1	565,41
2103600140	14,0	300	360	1	615,65
2103600160	16,0	300	360	1	728,70
2103600180	18,0	300	360	1	850,12
2103600200	20,0	300	360	1	954,79
2103600220	22,0	300	360	1	1.118,08
2103600250	25,0	300	360	1	1.419,53
2103600260	26,0	300	360	1	1.536,76
2103600280	28,0	300	360	1	1.762,86
2103600300	30,0	300	360	1	1.892,65
2104100080	8,0	350	410	1	498,42
2104100100	10,0	350	410	1	540,29
2104100120	12,0	350	410	1	565,41
2104100140	14,0	350	410	1	682,64
2104100160	16,0	350	410	1	804,06

# PTG

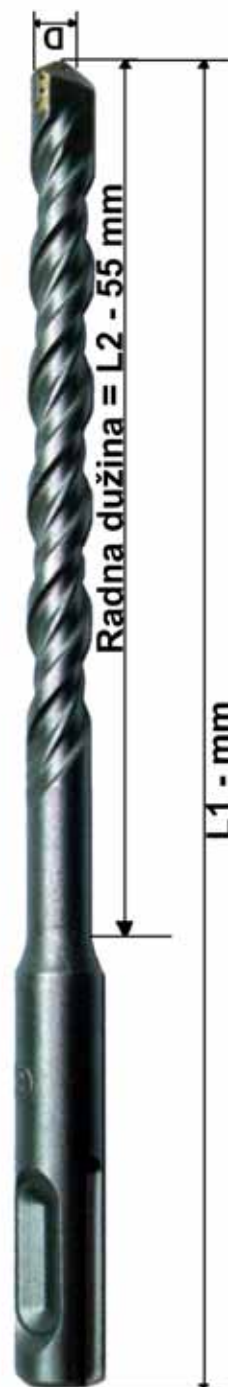

# Udarne burgije SDS - PLUS

Burgija za bušenje sve vrste kamena i betona,  
za profesionalne mašine

Broj artikla	Ø d - mm	L2 mm	L1 mm	Pakovanje Sadržaj	Cena/din po/kom
2104100180	18,0	350	410	1	933,85
2104100200	20,0	350	410	1	1.067,83
2104100220	22,0	350	410	1	1.231,12
2104100250	25,0	350	410	1	1.578,63
2104100260	26,0	350	410	1	1.687,49
2104100280	28,0	350	410	1	1.817,29
2104100300	30,0	350	410	1	1.926,14
2104600080	8,0	400	460	1	561,22
2104600100	10,0	400	460	1	607,28
2104600120	12,0	400	460	1	615,65
2104600130	13,0	400	460	1	674,27
2104600140	14,0	400	460	1	758,01
2104600160	16,0	400	460	1	879,43
2104600180	18,0	400	460	1	996,66
2104600190	19,0	400	460	1	1.063,65
2104600200	20,0	400	460	1	1.134,82
2104600220	22,0	400	460	1	1.398,60
2104600240	24,0	400	460	1	1.536,76
2104600250	25,0	400	460	1	1.708,43
2104600260	26,0	400	460	1	1.859,15
2104600280	28,0	400	460	1	1.926,14
2104600300	30,0	400	460	1	2.001,51
2106000080	8,0	550	600	1	711,95
2106000100	10,0	550	600	1	758,01
2106000120	12,0	550	600	1	799,87
2106000140	14,0	550	600	1	963,16
2106000160	16,0	550	600	1	1.080,40
2106000180	18,0	550	600	1	1.210,19
2106000200	20,0	550	600	1	1.344,17
2106000220	22,0	550	600	1	1.536,76
2106000240	24,0	550	600	1	1.771,23
2106000250	25,0	550	600	1	1.968,01
2106000260	26,0	550	600	1	2.076,87
2106000280	28,0	550	600	1	2.160,61
2106000300	30,0	550	600	1	2.483,00
2110000080	8,0	950	1000	1	933,85
2110000100	10,0	950	1000	1	1.139,01
2110000120	12,0	950	1000	1	1.210,19
2110000140	14,0	950	1000	1	1.406,97
2110000160	16,0	950	1000	1	1.524,20
2110000180	18,0	950	1000	1	1.641,44

## PTG

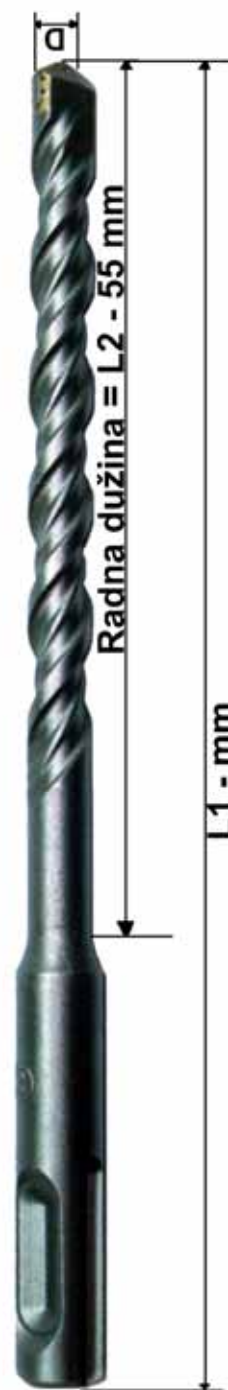

# Udarne burgije SDS - PLUS

SDS - PLUS burgija sa ukrštenim vrhom,  
buši rupe u betonu, kamenu i zidarskom materijalu.

Broj artikla	Ø d - mm	L2 mm	L1 mm	Pakovanje Sadrži	Cena/din po/kom
PTG3061100500	5,0	50	110	1	1.176,69
PTG3061100550	5,5	50	110	1	1.390,22
PTG3061100600	6,0	50	110	1	1.264,62
PTG3061100650	6,5	50	110	1	1.289,74
PTG3061100800	8,0	50	110	1	1.289,74
PTG3061101000	10,0	50	110	1	1.457,21
PTG3061600500	5,0	100	160	1	1.189,25
PTG3061600550	5,5	100	160	1	1.390,22
PTG3061600600	6,0	100	160	1	1.264,62
PTG3061600650	6,5	100	160	1	1.289,74
PTG3061600700	7,0	100	160	1	1.323,23
PTG3061600800	8,0	100	160	1	1.344,17
PTG3061601000	10,0	100	160	1	1.423,72
PTG3061601200	12,0	100	160	1	1.582,82
PTG3061601400	14,0	100	160	1	2.047,56
PTG3062100600	6,0	150	210	1	1.377,66
PTG3062100650	6,5	150	210	1	1.377,66
PTG3062100700	7,0	150	210	1	1.415,35
PTG3062100800	8,0	150	210	1	1.402,78
PTG3062101000	10,0	150	210	1	1.549,33
PTG3062101200	12,0	150	210	1	1.762,86
PTG3062101400	14,0	150	210	1	2.273,65
PTG3062101600	16,0	150	210	1	2.700,72
PTG3062600600	6,0	200	260	1	1.595,38
PTG3062600800	8,0	200	260	1	1.448,84
PTG3062601000	10,0	200	260	1	1.595,38
PTG3062601200	12,0	200	260	1	1.821,47
PTG3062601400	14,0	200	260	1	2.340,64
PTG3062601600	16,0	200	260	1	2.466,25
PTG3063100800	8,0	250	310	1	1.808,91
PTG3063101000	10,0	250	310	1	2.081,06
PTG3063101200	12,0	250	310	1	2.361,58
PTG3063101400	14,0	250	310	1	2.771,89
PTG3063101600	16,0	250	310	1	2.826,32
PTG3064600800	8,0	400	460	1	4.635,05
PTG3064601000	10,0	400	460	1	4.635,05
PTG3064601200	12,0	400	460	1	5.200,28
PTG3064601400	14,0	400	460	1	5.652,46
PTG3064601600	16,0	400	460	1	5.991,60
PTG3066101000	10,0	550	610	1	6.895,96
PTG3066101200	12,0	550	610	1	7.122,06
PTG3066101400	14,0	550	610	1	8.286,01
PTG3066101600	16,0	550	610	1	8.704,69

# PTG



## Burgija za kamen hobi (slika 1)

Broj artikla	Ø d - mm	Ukupna dužina	Pakovanje Sadrži	Cena/din po/kom
2300610030	3,0	61	10	25,50
2300750040	4,0	75	10	27,31
2300860050	5,0	86	10	34,09
2300930060	6,0	93	10	37,26
2301090070	7,0	90	10	44,95
2301170080	8,0	117	10	55,35
2301330100	10,0	133	10	71,63
2301510120	12,0	151	10	117,75
2301600140	14,0	160	10	173,37
2301600160	16,0	160	10	185,58
2302000050	5,0	200	5	71,63
2302000060	6,0	200	5	75,24
2302000080	8,0	200	5	98,30
2302000100	10,0	200	5	134,48
2302000120	12,0	200	5	183,32
2302000140	14,0	200	5	367,81
2304000060	6,0	400	1	110,06
2304000080	8,0	400	1	143,07
2304000100	10,0	400	1	208,19
2304000120	12,0	400	1	281,44
2304000140	14,0	400	1	380,92
2304000160	16,0	400	1	427,95
2304000180	18,0	400	1	546,87
2304000200	20,0	400	1	683,88
2304000220	22,0	400	1	732,72
2304000250	25,0	400	1	883,75



Slika 1



## Burgija za kamen profi (slika 2)



Slika 2

Broj artikla	Ø d - mm	Ukupna dužina	Pakovanje Sadrži	Cena/din po/kom
2410610030	3,0	60	10	51,28
2410750040	4,0	75	10	57,16
2410860050	5,0	85	10	72,98
2410930060	6,0	90	10	91,07
2411090070	7,0	100	10	113,68
2411170080	8,0	120	5	129,05
2411330100	10,0	133	5	266,06
2401500100	10,0	150	5	197,33
2411500120	12,0	150	5	259,73
2411500140	14,0	150	5	336,61
2402000060	6,0	200	1	119,11
2402000080	8,0	200	1	169,30
2402000100	10,0	200	1	229,44
2402000120	12,0	200	1	316,26
2402000140	14,0	200	1	401,72

# Špicasti sekač SDS-MAX



**PTG**

Broj artikla	Debljina mm	Dužina mm	Pakovanje	Cena/din po/kom
2502800018	18	280	1	2.018,46
2504000018	18	400	1	2.219,64
2506000018	18	600	1	3.627,90

## Pljosnati sekač SDS-MAX

**PTG**



Broj artikla	Debljina mm	Dužina mm	Širina sekača mm	Pakovanje	Cena/din po/kom
2502801825	18	280	25	1	2.018,46
2504001825	18	400	25	1	2.219,64
2506001825	18	600	25	1	3.627,90

## Široki i pljosnati sekač SDS-MAX



**PTG**

Broj artikla	Debljina mm	Dužina mm	Širina kanala mm	Pakovanje	Cena/din po/kom
2504001850	18	400	50	1	3.361,82

## Sekač za kanale SDS-MAX

**PTG**



Broj artikla	Debljina mm	Dužina mm	Širina kanala mm	Pakovanje	Cena/din po/kom
2502801826	18	280	25	1	5.107,54

## Špicasti sekač SDS-PLUS



**PTG**

Broj artikla	Debljina mm	Dužina mm	Pakovanje	Cena/din po/kom
2602500014	14	250	1	765,96

## Pljosnati sekač SDS-PLUS

**PTG**



Broj artikla	Debljina mm	Dužina mm	Pakovanje	Cena/din po/kom
2602501014	14	250	1	701,06

## Široki pljosnati sekač SDS-PLUS



**PTG**

Broj artikla	Debljina mm	Dužina mm	Širina sekača mm	Pakovanje	Cena/din po/kom
2602501440	14	250	40	1	876,28

## Sekač za kanale SDS-PLUS

**PTG**



Broj artikla	Debljina mm	Dužina mm	Širina kanala mm	Pakovanje	Cena/din po/kom
2602501422	14	250	22	1	1.038,53

# Burgija za drvo, brušene - profi

Specijalna za bušenje rupa u mekom i tvrdom drvetu

Broj artikla	Ø d - mm	Ukupna dužina	Pakovanje Sadržži	Cena/din po/kom
3100600030	3,0	60	1	22,79
3100750040	4,0	75	1	26,41
3100850050	5,0	85	1	39,07
3100950060	6,0	95	1	49,47
3101050070	7,0	105	1	65,75
3101150080	8,0	115	1	89,26
3101150090	9,0	115	1	110,06
3101300100	10,0	130	1	128,15
3101500110	11,0	150	1	146,69
3101500120	12,0	150	1	181,96
3101500130	13,0	150	1	210,90
3101500140	14,0	150	1	256,57
3101600150	15,0	160	1	312,64
3101600160	16,0	160	1	343,84
3101600180	18,0	160	1	884,65
3101600200	20,0	160	1	1.171,79
3102500060	6,0	250	1	183,77
3102500080	8,0	250	1	253,86
3102500100	10,0	250	1	320,33
3102500120	12,0	250	1	417,55
3102500140	14,0	250	1	598,42
3102500160	16,0	250	1	779,29
3102500180	18,0	250	1	875,61
3102500200	20,0	250	1	1.087,23



## Set burgija i glodala za drvo

Set sadrži 5 burgija za drvo veličine 4 - 6 - 8 - 10 - 12 mm i jednu glodalicu dimenzije 12 mm



Broj artikla	Ø d - mm	Jedno Pakovanje Sadržži	Cena/din po/kom
B50401	4,0-12	6	2.002,35

## Burgija za grede ( slika 1 )

Broj artikla	Ø d - mm	Ukupna dužina	Pakovanje sadrži	Cena/din po/kom
3312300060	6,0	230	1	324,66
3312300080	8,0	230	1	324,66
3312300100	10,0	230	1	389,56
3313200060	6,0	320	1	389,56
3313200080	8,0	320	1	454,46
3313200100	10,0	320	1	519,35
3313200120	12,0	320	1	649,15
3313200140	14,0	320	1	778,94
3314600080	8,0	460	1	649,15
3314600100	10,0	460	1	778,94
3314600120	12,0	460	1	908,73
3314600140	14,0	460	1	1.038,53
3314600160	16,0	460	1	1.168,32
3314600180	18,0	460	1	1.298,11
3314600200	20,0	460	1	1.557,70
3314600220	22,0	460	1	1.817,29
3314600240	24,0	460	1	2.076,87
3314600260	26,0	460	1	2.336,46
3314600280	28,0	460	1	2.725,84
3314600300	30,0	460	1	2.985,42
3314600320	32,0	460	1	3.374,80
3316200060	6,0	620	1	778,94
3316200080	8,0	620	1	908,73
3316200100	10,0	620	1	1.038,53
3316200120	12,0	620	1	1.298,11
3316200140	14,0	620	1	1.427,91
3316200160	16,0	620	1	1.557,70
3316200180	18,0	620	1	1.817,29
3316200200	20,0	620	1	2.076,87
3316200220	22,0	620	1	2.466,25
3316200240	24,0	620	1	2.855,63
3318800120	12,0	880	1	1.687,49
3318800140	14,0	880	1	1.817,29
3318800160	16,0	880	1	2.206,66
3318800180	18,0	880	1	2.466,25
3318800200	20,0	880	1	2.985,42
3318800220	22,0	880	1	3.504,60
3318800240	24,0	880	1	4.023,77

slika 1



slika 2



## Burgija za oplatae ( slika 2 )

Broj artikla	Ø d - mm	Ukupna dužina	Pakovanje	Cena/din po/kom
3616000060	6,0	600	1	785,44
3616000080	8,0	600	1	791,78
3616000100	10,0	600	1	869,10
3616000120	12,0	600	1	1.112,82
3616000130	13,0	600	1	1.196,48
3616000140	14,0	600	1	1.286,46
3616000150	15,0	600	1	1.523,86
3616000160	16,0	600	1	1.768,04
3616000170	17,0	600	1	1.980,11
3616000180	18,0	600	1	2.192,18
3616000190	19,0	600	1	2.326,93
3616000200	20,0	600	1	2.247,23
3616000220	22,0	600	1	2.461,39
3616000240	24,0	600	1	2.798,85
3616000260	26,0	600	1	3.415,37
3616000280	28,0	600	1	3.726,88
3616000300	30,0	600	1	4.168,17

# Pljosnata burgija za drvo (slika 1)

Broj artikla	Ø d - mm	Ukupna dužina	Pak- ovanje Sadrži	Cena/din po/kom
3401500060	6,0	150	1	113,50
3401500080	8,0	150	1	113,50
3401500100	10,0	150	1	115,76
3401500120	12,0	150	1	116,21
3401500130	13,0	150	1	128,42
3401500140	14,0	150	1	135,21
3401500150	15,0	150	1	141,08
3401500160	16,0	150	1	141,08
3401500170	17,0	150	1	147,42
3401500180	18,0	150	1	153,29
3401500190	19,0	150	1	164,60
3401500200	20,0	150	1	179,52
3401500220	22,0	150	1	192,63
3401500240	24,0	150	1	205,29
3401500250	25,0	150	1	217,05
3401500260	26,0	150	1	218,86
3401500280	28,0	150	1	242,37
3401500300	30,0	150	1	254,58
3401500320	32,0	150	1	279,45
3401500340	34,0	150	1	306,58
3401500350	35,0	150	1	306,58
3401500360	36,0	150	1	318,79
3401500380	38,0	150	1	336,88
3401500400	40,0	150	1	355,87

Slika 1



## Frezer za šarke HSS (slika 2)

Broj artikla	Ø d - mm	Ukupna dužina	Pak- ovanje Sadrži	Cena/din po/kom
3500950100	10	95	1	541,27
3500950120	12	95	1	541,27
3500950140	14	95	1	547,14
3500950150	15	95	1	547,14
3500950160	16	95	1	553,02
3500950180	18	95	1	565,23
3500950200	20	95	1	565,23
3500950220	22	95	1	565,23
3500950240	24	95	1	589,65
3500950250	25	95	1	588,74
3500950260	26	95	1	589,65
3500950280	28	95	1	638,03
3500950300	30	95	1	643,91
3500950320	32	95	1	643,91
3500950340	34	95	1	716,71
3500950350	35	95	1	716,71
3500950360	36	95	1	747,01
3500950380	38	95	1	832,02
3500950400	40	95	1	977,17
3500950450	45	95	1	1.080,27
3500950500	50	95	1	1.213,66



Slika 2

DIN 7483 - G



# Držači za krune

Slika 1

Slika 2

Slika 3

Slika 4

**PTG**



Broj artikla	Slika	d 1	d 2 mm	d 3 prihvata	Pakovanje Sadržaji	Cena/din po/kom
PTG274400201	1	14-30	11	šestougaoni	1	986,61
PTG274400203	2	14-30	1/4" (6,35)	okrugli	1	869,80
PTG274400204	3	14-30	9,5	šestougaoni	1	986,61
PTG274400206	4	14-30	10	SDS-plus	1	1.298,11

Slika 1

Slika 2

Slika 3

**PTG**



Broj artikla	Slika	d 1	d 2 mm	d 3 prihvata	Pakovanje Sadržaji	Cena/din po/kom
PTG274400202	1	32-210	11	šestougaoni	1	1.817,29
PTG274400205	2	32-210	9,5	šestougaoni	1	1817,29
PTG274400207	3	32-210	10	SDS -plus	1	1.882,18

# Krone HSS Bi-metal profi

Kruna HSS Bi-metal, dubina rezanja 38 mm.  
Koristi se za sečenje metala, plastike, drveta,  
aluminijuma.

Broj artikla	Ø d 1 mm	Ø d 1 zoll	Pak- ovanje Sadrži	Cena/din po/kom
PTG274001400	14	9/16"	1	350,61
PTG274001600	16	5/8"	1	415,52
PTG274001700	17	-	1	454,46
PTG274001900	19	3/4"	1	467,44
PTG274002000	20	-	1	480,42
PTG274002100	21	-	1	519,35
PTG274002200	22	7/8"	1	558,29
PTG274002400	24	15/16"	1	584,25
PTG274002500	25	1"	1	623,19
PTG274002700	27	1.1/16"	1	662,13
PTG274002900	29	1.1/8"	1	688,08
PTG274003000	30	1.3/16"	1	727,02
PTG274003200	32	1.1/4"	1	752,98
PTG274003300	33	-	1	791,92
PTG274003500	35	1.3/8"	1	843,84
PTG274003700	37	-	1	869,80
PTG274003800	38	1.1/2"	1	882,77
PTG274004000	40	-	1	895,75
PTG274004100	41	1.5/8"	1	934,69
PTG274004300	43	1.11/16"	1	960,65
PTG274004400	44	1.3/4"	1	986,61
PTG274004500	45	-	1	1.064,48
PTG274004600	46	1.13/16"	1	1.064,48
PTG274004800	48	1.7/8"	1	1.064,48
PTG274005000	50	-	1	1.129,38
PTG274005100	51	2"	1	1.129,38
PTG274005200	52	-	1	1.194,28
PTG274005400	54	2.1/8"	1	1.246,20
PTG274005500	55	-	1	1.246,20
PTG274005700	57	2.1/4"	1	1.285,13
PTG274005900	59	-	1	1.337,05
PTG274006000	60	2.3/8"	1	1.453,86
PTG274006400	64	2.1/2"	1	1.544,72
PTG274006500	65	-	1	1.557,70
PTG274006700	67	2.5/8"	1	1.570,68
PTG274006800	68	-	1	1.583,66
PTG274007000	70	2.3/4"	1	1.622,60
PTG274007300	73	2.7/8"	1	1.635,57
PTG274007500	75	-	1	1.739,41
PTG274007600	76	3"	1	1.739,41

## PTG



Broj artikla	Ø d 1 mm	Ø d 1 zoll	Pak- ovanje Sadrži	Cena/din po/kom
PTG274007900	79	3.1/8"	1	1.765,37
PTG274008300	83	3.1/4"	1	1.921,12
PTG274008600	86	3.3/8"	1	1.973,04
PTG274008900	89	3.1/2"	1	2.011,97
PTG274009200	92	3.5/8"	1	2.141,77
PTG274009500	95	3.3/4"	1	2.232,62
PTG274009800	98	3.7/8"	1	2.310,50
PTG274010000	100	-	1	2.336,46
PTG274010200	102	4"	1	2.362,42
PTG274010500	105	-	1	2.414,33
PTG274010800	108	4.1/4"	1	2.505,19
PTG274011100	111	4.3/8"	1	2.557,11
PTG274011400	114	4.1/2"	1	2.660,94
PTG274012100	121	4.3/4"	1	2.959,46
PTG274012700	127	5"	1	3.076,28
PTG274014000	140	5.1/2"	1	3.517,57
PTG274014600	146	-	1	3.699,29
PTG274015200	152	6"	1	3.855,04

## Rezervna burgija za držač krune



**PTG**

Slika 1



Slika 2

Broj artikla	Slika	d mm	Pakovanje Sadrži	Cena/din po/kom
PTG274400301	1	6,35x75	1	571,27
PTG274400302	2	6,35x105	1	714,04

## Produžetak za držač za krune



**PTG**

Broj artikla	d 1 mm	d 2 mm	Pakovanje Sadrži	Cena/din po/kom
PTG274400305	300	11	1	1.518,76

## Rezervna matica i rezervni feder za krune



Slika 1



Slika 2

Broj artikla	Slika	Pakovanje Sadrži	Cena/din po/kom
PTG274400306	1	1	324,66
PTG274400307	2	1	104,02

**PTG**

# Krone HSS Bi-metal profi, setovi

ALLROUND, u plastičnoj kutiji, sadrži 9 komada. Ispunjeno sa  $\varnothing$  22/ 29/ 35/ 44/ 51 + 64 mm  
2 nosača dimenzije: 14 - 30 mm i 32 - 210 mm, sa šestougaonim prihvatom u dimenzijama 9,5 i 11 mm plus federom za izbacivanje otpada.

Broj artikla	Pakovanje Sadržai	Cena/din po/kom
PTG274070009	9	9.215,49



**PTG**

**PTG**



ELEKTRO, u plastičnoj kutiji, sadrži 14 komada. Ispunjeno sa  $\varnothing$  16/ 20/ 22/ 25/ 29/ 35/ 44/ 51/ 64/ 68 + 76 mm, 2 nosača dimenzije: 14 - 30 mm i 32 - 210 mm, sa šestougaonim prihvatom u dimenzijama 9,5 i 11 mm plus federom za izbacivanje otpada.

Broj artikla	Pakovanje Sadržai	Cena/din po/kom
PTG274070014	14	14.277,43

UNIVERSAL, u plastičnoj kutiji, sadrži 14 komada. Ispunjeno sa  $\varnothing$  16/ 20/ 22/ 25/ 29/ 32/ 35/ 38/ 44/ 51/ 57/ 64/ 68/ 76mm, 2 nosača dimenzije: 14 - 30 mm i 32 - 210 mm, sa šestougaonim prihvatom u dimenzijama 9,5 i 11 mm plus federom za izbacivanje otpada.

Broj artikla	Pakovanje Sadržai	Cena/din po/kom
PTG274070017	17	17.132,87



**PTG**

**PTG**



PREMIUM plus, u aluminijumskoj kutiji, sadrži 16 komada. Ispunjeno sa  $\varnothing$  19/ 20/ 22/ 25/ 29/ 35/ 38/ 40/ 48/ 60/ 65/ 68/ 86mm, 2 nosača dimenzije: 14 - 30 mm i 32 - 210 mm, sa šestougaonim prihvatom u dimenzijama 9,5 i 11 mm plus federom za izbacivanje otpada.

Broj artikla	Pakovanje Sadržai	Cena/din po/kom
PTG274080016	16	19.339,36